



If you don't see the parts you need on the following pages, please SEND A SAMPLE for identification!

## Ordering Information / Index

### Ordering Information

**Toll Free Express Ordering:** Customers may place express orders by calling 800-678-1919 (from continental U.S.) from 8 a.m. - 5 p.m. eastern time, Monday through Friday.

**Ordering Information:** Our catalog has been designed to make ordering as easy as possible. It is not possible to list all of the items available through Blaine. If you need items, that do not appear in our catalog, please send a sample to our Research Department at 17319 Blaine Drive, Hagerstown, Md 21740-2394. To help expedite your orders, please use our part numbers, quantities required and include your account number, if possible, on your purchase orders.

**Delivery Status:** Any delivery dates set forth by Blaine Window are estimates only and are not intended as a guarantee of date of delivery. Our pledge is for quick and efficient processing of your order. However, due to the nature of our business, stock shortages may occur from time to time. Items will remain on back-order until shipped. Blaine Window Hardware will not be liable for any delay in delivery or failure to deliver any or all of the goods in case such delay results from causes beyond our control. Order status may be obtained by calling our office at 800-678-1919.

**Damages / Shortages:** All material, in transit, is the property of the buyer and buyer assumes all responsibility for filing claims and damages. **Please inspect all freight for visible damage prior to accepting. Do not accept cartons which show damage or are open. Claims for concealed damage must be made by the buyer, with the carrier, within ten (10) working days.**

Original shipping carton must be retained.

Shortages must be reported to us at 800-678-1919 within ten (10) working days.

**Returns:** All returns / exchanges must be made within 30 days from receipt of material. Authorization numbers are available by calling us at 800-678-1919. All authorization numbers must appear on the outside of the carton and merchandise must be shipped prepaid to our warehouse. Shipping charges will not be credited on returns unless authorized in writing by Customer Service. Any unauthorized returns will be refused. A restocking fee of 25% will be charged for returns when the customer ordered incorrectly. We strongly urge you to send a sample to eliminate doubt when placing orders. Special order or custom made parts are not returnable unless defective.

### Terms & Conditions

**Credit Policy:** Terms are net 30 days for open account customers. All other orders must be pre-paid or shipped C.O.D. unless otherwise specified. Partial payment in advance may be required with an order. We accept all major credit cards.

**C.O.D.:** Orders may be shipped on a Cash on Delivery (C.O.D.) basis. Our Accounting Department may require cash, cashiers check, certified check or money order for payment. The current U.P.S. C.O.D. charge is \$9.00 per carton. The refusal of a C.O.D. shipment, for any reason other than apparent damage may cause your account to be coded cash in advance only.

**Special Orders:** Non stock parts (special orders) may require a minimum order quantity.

**Stock Parts :** For orders less than \$25.00, there will be a \$5.00 processing fee.

**Freight:** All shipments will be made by the carrier of our choice, usually U.P.S. or Post Office., unless specified otherwise. We also offer UPS Next Day and Second Day service when requested. This customer is responsible for all shipping charges unless otherwise specified. Common carrier service is also available. A \$8.50 minimum shipping and handling charge is applied to each order. Actual shipping charges will be added when minimum is exceeded.

**State Sales Tax:** Customers exempt from state sales tax must provide a certificate of exemption with initial order.

**Samples:** Can be sent to our Research Department or e-mail photos to: [blainehdw@aol.com](mailto:blainehdw@aol.com)

### INDEX

Accessories.....	6	Global Steel Hardware.....	41 - 42
Accurate Parts.....	37	Grab Bars.....	9
Alcove Clips & End Plugs.....	33	Hadrian Hardware.....	42
All American Parts.....	37	Headrail Brackets.....	34
American Sanitary Parts.....	37	Hooks & Latches.....	45
AMPCO.....	37 - 38	Knickerbocker Hardware.....	42
Bobrick Parts.....	38	Metpar Hardware.....	42 - 43
Cams, Pintles & Hinge Pins.....	46	Mills Hardware.....	43
Color Charts.....	22 - 24	New Items.....	47
Columbia Parts.....	38	Pilaster Post Anchoring Packs.....	31
Compartments Construction.....	3 - 5	Pilaster Shoes & Anchoring Devices.....	30
Plastic Laminate, Solid Plastic, Steel Powder Coat		Pre-packaged Hardware.....	14 - 15
Comres Manufacturing.....	39	Alcove, Angle, Headrail & Urinal Brackets	
Comtec Hardware.....	39	Panel & Pilaster Packs	
Concealed Latches & Knobs.....	29	Quick Fix & latch Repair Kits.....	45
Door Hardware.....	10 - 11	Santana Hardware.....	44
Inswing & Outswing		Sanymetal Hardware.....	44
Top & Bottom Hinges		Shanahan Hardware.....	44
Door Inserts.....	32	Screw Packs & Fasteners.....	35
Door Pull Fix ItKits.....	29	Strikes & Keepers.....	20 - 21
Door Stops.....	27	Surface Mounted Hinges.....	19
Door Packs, Surface Mounted.....	12 - 13	Toilet Partition Size Information.....	7
Entry & Urinal Screens Size Information.....	7	Toilet Partition Layouts.....	8
Fasteners.....	35 - 36	Wall Brackets.....	16 - 18
Fiat.....	39	Wrap Around Gravity Pivot Hinges.....	25 - 26
Flush Metal Hardware.....	40		
General Partition.....	40 - 41		

## Construction Styles of Toilet Compartments

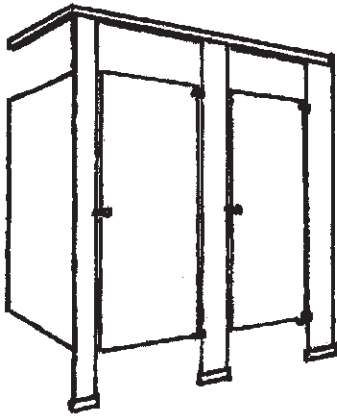

### HEADRAIL BRACED (Most Popular)

For easy, economical installations, the headrail braced is a great choice. This unit requires no special floor construction; therefore, it can be used in new or old buildings.

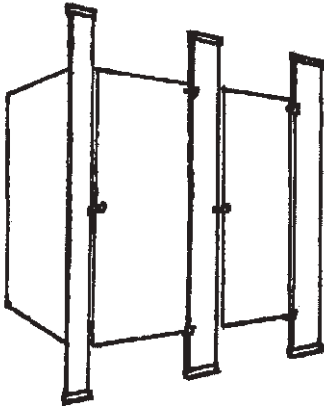

### FLOOR TO CEILING

Floor to ceiling is recommended for all areas subject to heavy usage. For problem areas we recommend the use of full length aluminum brackets and hinges.

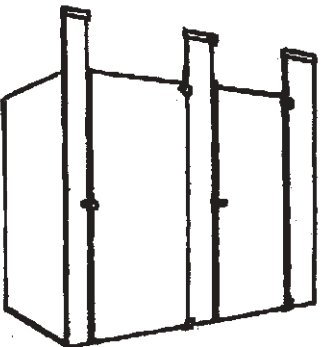

### CEILING HUNG

Ceiling hung partitions combine functional styling with an unobstructed floor area which simplifies cleaning and reduces the cost of maintenance.

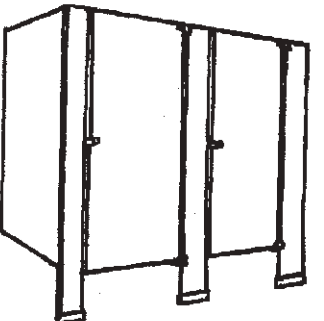

### FLOOR SUPPORTED

Floor supported partitions have the same functional lines as ceiling hung partitions without the top structure.

Comtec's solid plastic compartments come closer to being totally maintenance free than any other toilet compartments on the market today.

**Comtec** is a seamless, one piece, solid homogenous polymer resin sheet produced under heat and high pressure.

The compartment panels, doors and pilasters are manufactured to handle the toughest requirements and meet construction needs. The texture gloss finish is an ideal material for applications from toilet compartment systems to dressing room compartments with an emphasis on the needs of the handicapped.

**Comtec** is exceptionally resistant to marking by pens, cosmetics, pencils, most markers and paints. . . easily cleaned using a non-abrasive Industrial-Strength detergent.

**Comtec** sheets and compartments are available to meet a wide range of applications including vanity tops, benches and other related products.

**Comtec** products and systems are designed to hold-up under the toughest of conditions and environments with little or NO maintenance. The products and materials are designed and engineered to withstand the most rigorous use and will maintain the "Same Quality Appearance" as the day they were installed.

### GRAFFITI RESISTANT

Applications - Ideal for wet, corrosive areas that receive high use including schools, parks, gas stations, amusement areas, swimming pools and factories.

### ASTME 84 TESTED CLASS "A" MATERIAL AVAILABLE

### COST EFFECTIVE

Comtec compartments are a cost effective solution for public restroom construction and replacement . . . saving maintenance dollars.

### LOW MAINTENANCE

Comtec compartments are designed to be a low maintenance system and provide an attractive design feature to building maintenance engineers. The protective finish of Comtec is self lubricating and resists ink, pencil, cosmetics and most other instruments. In most instances, stains and marks can be easily removed with a common industrial cleaner. The color of the compartment is homogeneously compounded throughout the material. (Paint will not adhere to the surface of Comtec). Excessive moisture, corrosion from steam cleaning or pressure hose methods of maintenance will not harm Comtec.

### COMTEC / CAPITOL GUARANTEE

Comtec/Capitol guarantees its panels against breakage, corrosion and delamination for 15 years from the date of receipt by the customer  
(Labor not included in Comtec Warranty)

Plastic laminate products provide the best solution when durability and beauty are required. They provide architects and designers unlimited color and pattern selection, combined with graffiti resistance, ease of maintenance and durability.

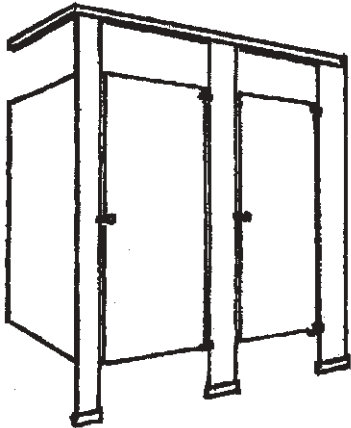

Available in four construction styles - headrail braced, ceiling hung, floor to ceiling and floor supported. Color to be selected from manufacturer's stand charts for this product.

### Sunlight (quick ship series)

Quick ship series compartments are ideal for projects requiring immediate shipment. Customers doing renovations, tenant work and fast tract projects can rely on a complete inventory of items and the most dependable delivery in the industry. We offer 3 neutral colors to complement any restroom design. Panels and doors have a thickness of 7/8" and pilasters are 1-1/4" thick. Standard hardware is chrome plated institutional quality. Stainless steel hardware, chrome plated brass and continuous hardware are available as an extra cost option (selection of optional hardware may increase delivery times). Unlike many companies, the quick shipment of this series compartment is offered at no extra cost, and this product is also priced economically, making it a great value.

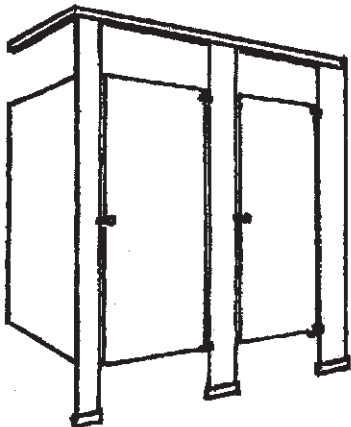

Available in four construction styles - headrail braced, ceiling hung, floor to ceiling and floor supported. Color to be selected from manufacturer's stand charts for this product.

### Sunburst (special order series)

Special order series compartments set the architectural standard by offering unlimited color flexibility combined with the finest quality product line. Special order series compartments are the ideal solution for all types of public facilities. Several hundred colors and patterns are available enabling architects and designers the ability to use durable plastic laminates without compromising color designs. Panels and doors are a full 1 inch thick and pilasters are 1-1/4" thick. Standard hardware is chrome plated institutional quality. Stainless steel hardware, chrome plated brass hardware, and continuous hardware are available at extra cost. Our lead times for this product line are the quickest in the industry. Over the years we have proven our ability to produce special orders quickly without unnecessary up charges. Better service, enhanced color selection and quick delivery do not translate to extended lead times and higher costs with this series.

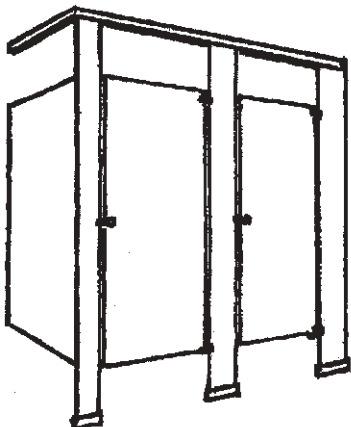

Available in four construction styles - headrail braced, ceiling hung, floor to ceiling and floor supported. Color to be selected from manufacturer's stand charts for this product.

### Eclipse (phenolic core compartments)

Phenolic material is a solid plastic material made of laminate color sheets thermally fused to a phenolic core. The color sheets are fused under heat and pressure to the core to form a solid sheet. Solid core products are ideal for areas that require extreme durability. Virtually unbreakable and waterproof, they can be used in wet areas or areas that require hose down cleaning. Abusive areas can rely on the strength of the core to eliminate breakage. Unlike other solid plastic materials, color selection is unlimited. The same range of colors and patterns are available for phenolic that are available for any plastic laminate. With unlimited color selection, architects and designers can achieve the color coordination in their designs without sacrificing the desirable properties of a solid plastic. Doors and pilasters are 3/4" thick and panels are 1/2" thick. Standard hardware is stainless steel. Continuous stainless and continuous aluminum brackets and hinges are available as an extra cost option.

**FEATURES**

1. All partitions have welded construction on perimeters and corners.
2. For protection against rust, all steel is galvanized and bonderized with .00015 zinc coating.
3. All hardware is heavy Zamac castings, chrome plated. Brass available at extra charge as specified.
4. All parts are pre drilled for ease of installation.

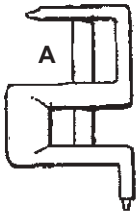
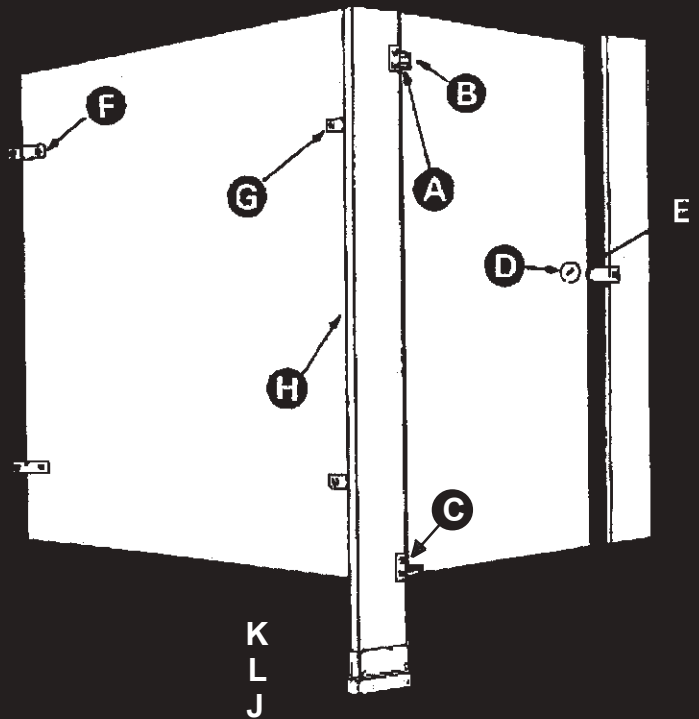

**A.** Upper door bracket and stainless steel pin. This is a heavy Zamac casting made an integral part of the door as it is inbedded with in pre-formed abscesses. The stainless steel pin goes through door and brack for three-point bearings. Operates in a zytel self-lubricating bushing.

**B.** Top hinge bracket  
**C.** Bottom hinge bracket

These are heavy Zamac No. 3 castings, chrome plated with a 5/8" flange which wraps around the pilaster for maximum strength. Hinge brackets are through-bolted with one way, theft-proof screws. The bottom hinge works on opposing zytel cams which are self lubricating to insure trouble free operation and quiet action.

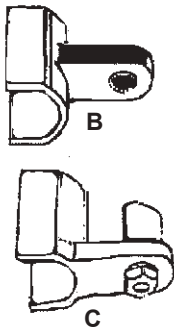

**D.** Concealed latch and emergency cover plate. Latch has a fully concealed case made of Zamac No. 3 castings with stainless steel bolt and mortised face plates fully tamper and theft proof. Cover plate is a Zamac No. 3 chrome plated casting which snaps in place. This has a slot for emergency entrance feature as standard.

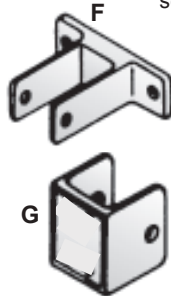

**F.** Wall bracket and **G.** Pilaster brackets are heavy Zamac No. 3 chrome plated castings or anodized aluminum.

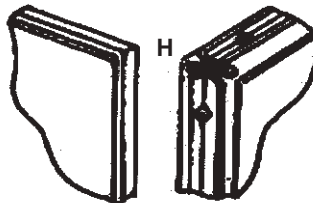

**H.** Welded construction. We weld the doors and pilasters 18" on center around the entire perimeter for maximum strength and durability. We weld and grind all corners. No corner clips are used.



**E.** Doorstrike and keeper. Heavy Zamac No. 3 chrome plated castings with a wrap around flange for maximum durability that is through bolted with one way theft proof screws.

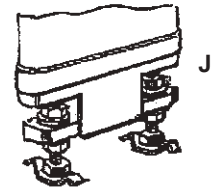

**J.** Carrying member for Type aamco Floor supported is a 1/2" x 1" solid bar for maximum strength and durability. This saves installation time and assures a plumb and long lasting installation.

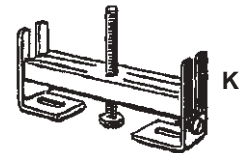



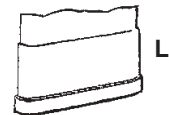





**K.** Jack-leveling device for Type aamco Headrail Braced is used as standard. Heavy-duty bolt provides loadbearing and a permanent base for panels and pilaster with the use of levelling screws. This saves installation time and assures a plumb and long lasting installation.



**L.** Pilaster Shoe. Shoe is made of 302 stainless steel and is of one piece construction. Shoe assembly has snap down action on a concealed hold down clip. This eliminates unsightly screws and saves on installation time. Shoe is vandal-proof and cannot be removed.

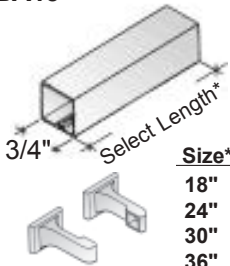

**Toilet Partition Accessories**

<p><b>BA-1</b></p>  <p><b>Size</b> 30 X 30 32 X 32 34 X 34 36 X 36</p>	<p><b>BA-2</b></p>  <p><b>Size</b> 30 X 30 32 X 32 36 X 36</p> <p><b>Stainless Steel Angle Frame Mirror With Shelf</b></p>	<p><b>BA-3</b> 1/2 Quart Capacity</p>  <p><b>Surface Mount Soap Dispenser</b></p>	<p><b>BA-4</b></p>  <p><b>Stainless Steel Shelf With Soap Dispenser</b></p>	<p><b>BA-5</b></p>  <p><b>Stainless Steel Towel / Waste Disposal - 21 Gallon Capacity</b></p>
<p><b>BA-6</b></p>  <p><b>Paper Towel Dispenser</b></p>	<p><b>BA7</b></p>  <p><b>Recessed Dual Roll Stainless Steel Toilet Paper Dispenser</b></p>	<p><b>BA8</b></p>  <p><b>Heavy Duty Robe Hook</b></p>	<p><b>BA-9-5X16</b> <b>BA-9-5X30</b> <b>BA-9-6X12</b> <b>BA-9-6X18</b></p>  <p><b>Stainless Steel Shelving Available In 5", 6" &amp; 8" Depths</b></p>	<p><b>BA15</b></p>  <p><b>Aluminum Towel Bar w/ Brackets</b></p> <p><b>Size*</b> 18" 24" 30" 36"</p>

\*\* Many other accessories, not shown here, also available from Blaine. Please call Customer Service for assistance. \*\*

**Brackets, shown below, are used with solid plastic toilet partition panels.**

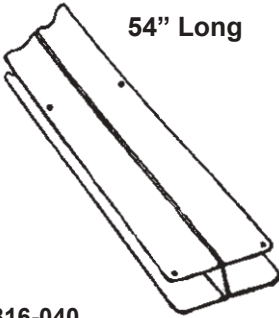
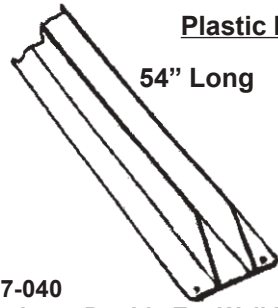
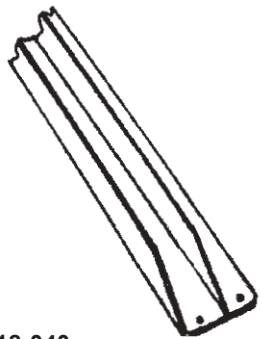
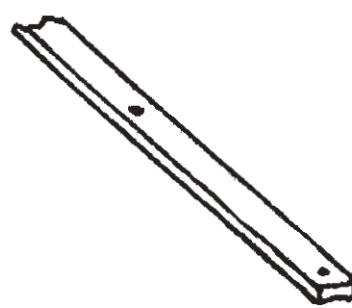
 <p><b>54" Long</b></p> <p><b>9816-040</b> <b>Aluminum "H" Bracket</b></p> <p><b>9816-034</b> <b>Stainless Steel "H" Bracket</b></p>	<p><b>Plastic "H" Bracket</b></p> <p>09816-Beige-058 09816-Black-058 09816-Burgundy-058 09816-Mocha-058 09816-Glacier Gray-058 09816-Hunter Green-058 09816-Blueberry-058 09816-Sand Castle-058 09816-Fossil-058 09816-White-058</p>	 <p><b>54" Long</b></p> <p><b>9817-040</b> <b>Aluminum Double Ear Wall Bracket</b></p> <p><b>9817-034</b> <b>Stainless Steel Double Ear Wall Bracket</b></p> <p><b>9817-Beige-058</b> <b>9817-Black-058</b> <b>9817-Burgundy-058</b> <b>9817-Mocha-058</b> <b>9817-Glacier Gray-058</b> <b>9817-Hunter Green-058</b> <b>9817-Blueberry-058</b> <b>9817-Sand Castle-058</b> <b>9817-Fossil-058</b> <b>9817-White-058</b></p>
 <p><b>9818-040</b> <b>Aluminum Single Ear Wall Bracket</b></p> <p><b>9818-034</b> <b>Stainless Steel Single Ear Wall Bracket</b></p>	<p><b>Plastic Single Ear Wall Bracket</b></p> <p>09818-Beige-058 09818-Black-058 09818-Burgundy-058 09818-Mocha-058 09818-Glacier Gray-058 09818-Hunter Green-058 09818-Blueberry-058 09818-Sand Castle-058 09818-Fossil-058 09818-White-058</p>	 <p><b>9819-040</b> <b>Heat Sink Bar</b></p>

**Blaine Lavatory Partitions**

**DOORS**

**Stock Number**

- TPDR9100
- TPDR9101
- TPDR9102
- TPDR9103
- TPDR9104
- TPDR9105
- TPDR9106
- TPDR9107



- 21-5/8" w x 58" h Door
- 23-5/8" w x 58" h Door
- 25-5/8" w x 58" h Door
- 27-5/8" w x 58" h Door
- 29-5/8" w x 58" h Door
- 31-5/8" w x 58" h Door
- 33-5/8" w x 58" h Door
- 35-5/8" w x 58" h Door

**PANELS**

- TPPL9108
- TPPL9109
- TPPL9110
- TPPL9111
- TPPL9112
- TPPL9113
- TPPL9114
- TPPL9115
- TPPL9116
- TPPL9117
- TPPL9118
- TPPL9119
- TPPL9120
- TPPL9121
- TPPL9122
- TPPL9173
- TPPL9174



- 15-1/2" w x 58" h Panel
- 17-1/2" w x 58" h Panel
- 21-1/2" w x 58" h Panel
- 23-1/2" w x 58" h Panel
- 25-1/2" w x 58" h Panel
- 27-1/2" w x 58" h Panel
- 29-1/2" w x 58" h Panel
- 31-1/2" w x 58" h Panel
- 33-1/2" w x 58" h Panel
- 35-1/2" w x 58" h Panel
- 37-1/2" w x 58" h Panel
- 39-1/2" w x 58" h Panel
- 45-1/2" w x 58" h Panel
- 51-1/2" w x 58" h Panel
- 54-1/2" w x 58" h Panel
- 57-1/2" w x 58" h Panel
- 69-1/2" w x 58" h Panel

**PILASTERS**

- TPPR9124
- TPPR9125
- TPPR9126
- TPPR9127
- TPPR9128
- TPPR9129
- TPPR9130
- TPPR9131



- 3" w x 82" h Pilaster
- 4" w x 82" h Pilaster
- 5" w x 82" h Pilaster
- 6" w x 82" h Pilaster
- 7" w x 82" h Pilaster
- 8" w x 82" h Pilaster
- 10" w x 82" h Pilaster
- 12" w x 82" h Pilaster

**ALUMINUM HEADRAILS**

- TPAH9134
- TPAH9135
- TPAH9136
- TPAH9137
- TPAH9138
- TPAH9139
- TPAH9140
- TPAH9142



- 37" L Aluminum Headrail
- 56" L Aluminum Headrail
- 66" L Aluminum Headrail
- 70" L Aluminum Headrail
- 72" L Aluminum Headrail
- 74" L Aluminum Headrail
- 82" L Aluminum Headrail
- 96" L Aluminum Headrail

**SCREENS & POSTS**

- TPSP9123 6" x 70" h Screen Pilaster-use a 35-1/2"-45-1/2" w panel for pilaster supported urinal screen (sold separately)
- TPUS9132 18" w x 42" h bracket supported screen
- TPUS9133 24" w x 42" h bracket supported screen
- TPAP9142-040 Aluminum Post - 1-3/4" x 1-3/4" x 70" h

Doors, panels, pilasters and urinal screens - specify steel by adding 050 to the end of the stock number or plastic laminate by adding 058. Alum. headrail - specify 040 for use on steel pilasters or PL-040 for use on plastic laminate pilasters.

**Entry And Urinal Screens**

Complete with mounting hardware

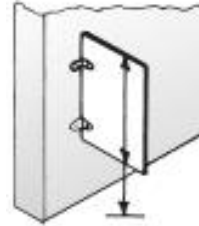

**Bracket Supported Finishes:**  
Baked enamel on steel and high pressure plastic laminate.

**Sizes:**  
18" w x 42" h  
24" w x 42" h

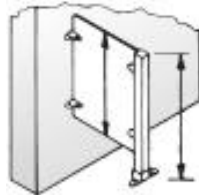

**Post Supported Finishes:**  
Baked enamel on steel and high pressure plastic laminate.

**Panel Sizes:**  
15-1/2" x 17-1/2" x 21-1/2",  
23-1/2", 25-1/2", 27-1/2", 29-1/2",  
31-1/2" and 33-1/2" wide x  
58" high

**Aluminum Post:**  
1-3/4" x 1-3/4" x 70" high



**Pilaster Supported Finishes:**  
Baked enamel on steel and high pressure plastic laminate.

**Panel Sizes:**  
35-1/2", 37-1/2", 39-1/2" and  
45-1/2" wide x 58" high

**Pilaster Size:**  
6" w x 70" high

**For more information regarding our Toilet Partitions, including color selection and material used, please contact our Customer Service Department at 800-678-1919.**

## Blaine Standard Toilet Partition Layouts

Determine the following when ordering Baked Enamel on Steel, Stainless Steel, High Pressure Laminate, Solid Phenolic Laminate & Solid Plastic Polymer Partitions:

- Determine Layout Type (see Below):
  - Free Standing
  - In Corner
  - Between Walls
  - Alcove
  - Entry & Urinal Screens
- Partition Type and Style:
  - A. Solid Plastic, Metal or Laminate
  - B. Type of Brace Required (headrail, floor, ceiling hung)
- Complete Layout of Toilet Partition Stall(s)
  - A. Width of stall
  - B. Depth of stall
  - C. Total width available
  - D. Width of doors, if known.
- Indicate whether a handicapped accessible unit (ADA) is required.
- Indicate color required.

Metal partitions are solid in a standard 58" door height. Solid plastic partitions are sold in a standard 55" door height. Replacement doors, panels, pilasters and hardware are also available separately.

Typical Toilet Partition Layout

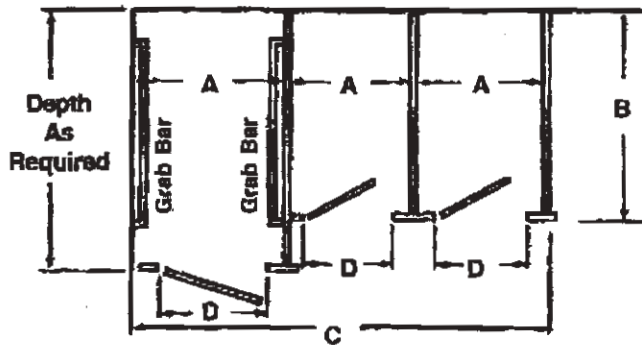

Finished Ceiling

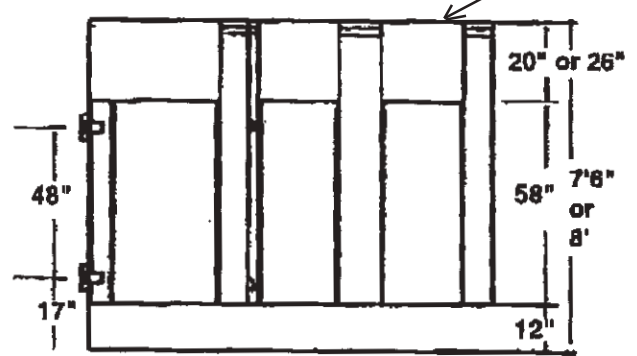

Ceiling Hung



Headrail Braced (most commonly used)



Floor Braced

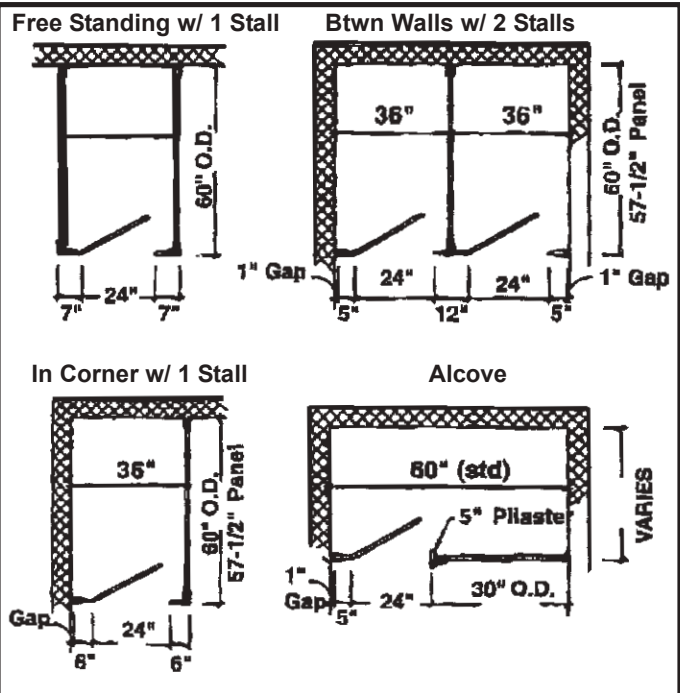

**GRAB BAR APPLICATIONS**

This is strictly a representation of the grab bars available through Blaine. Contact our Customer Service Department for detailed literature and assistance.

**STRAIGHT BARS**

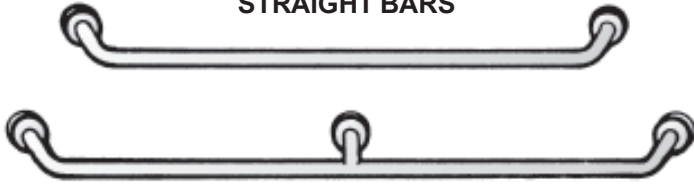

Specify center support when required

**BAR NUMBER**

- NUMBER 12
- NUMBER 16
- NUMBER 18
- NUMBER 24
- NUMBER 32
- NUMBER 36
- NUMBER 42
- NUMBER 48

**LENGTH**

- 12"
- 16"
- 18"
- 24"
- 32"
- 36"
- 42"
- 48"

**FLANGE SPECIFICATIONS**

TUBE DIAMETER	ROUND	CONCEALED	SNAP-ON
		<p>Three 1/4-20 set screws in lip</p>	<p>Cover rotates to expose mounting holes for easier installation</p>
1"	#73	#69	#89
1-1/4"	#74	#71	#90
1-1/2"	#75	#72	#91

**OTHER GRAB BAR APPLICATIONS**

**No. 5R** Right Hand Shown

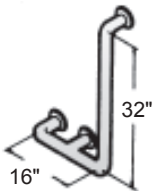

**No. 5L** Left Hand Shown

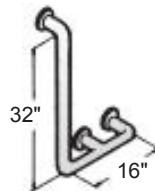

**No. 52**

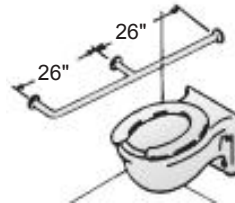

**No. 55**

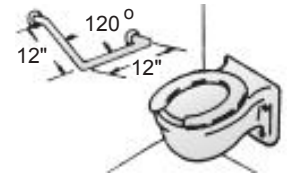

**No. 60**

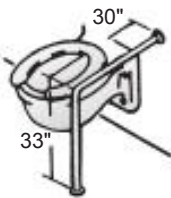

**No. 75R** Right Hand Shown

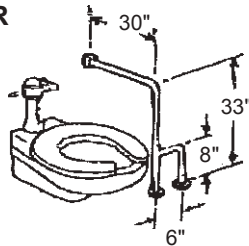

**No. 70**

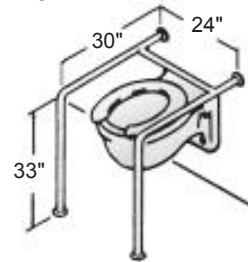

**No. 80**

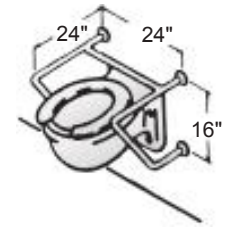

**No. 50**

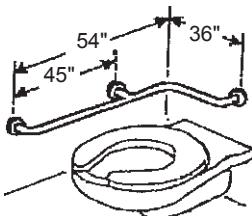

**No. 40** Right Hand Shown

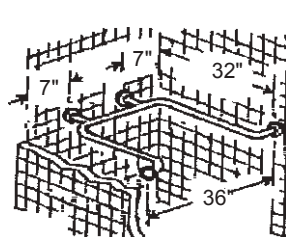

**No. 10** Non Handed

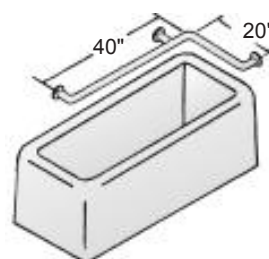

**No. 15**

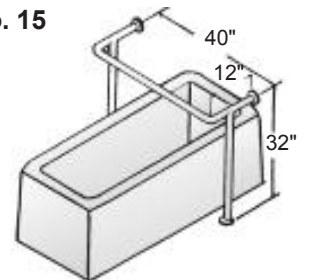



PART #		CONTENTS										ALSO AVAILABLE IN		
Door Size	Post Size	Chrome Plated Zamac	Latch	Top Hinge	Bottom Hinge	Strike/ Keeper	One Pc Keeper	One Pc Strike	Top Insert	Bottom Insert	Hinge Pin	Chrome Plated Brass	Polished Brass	Cast S.S.
1/2"	1/2"	19000	5030	3720	3220		5160	5170	2380	2390	99585			
1/2"	1"	18000	5020	3760	3260		5160	5170	2380	2390	99585			18003
7/8"	1-1/8"	18500	5020	36904	31904	56104			1540	1530	99109			
7/8"	1-1/4"	17800	5020	3790	3290	5110			1540	1530	99109	17801	17802	17803
7/8"	1-1/4"	17810	5020	3790	3290	5980			1540	1530	99109			17813
7/8"	1-1/4"	17830	5020	3790	3290	5340			1540	1530	99109	17831		17833
7/8"	1-1/4"	17900	5050	3790	3290	5110			1540	1530	99109	17901	17902	17903
1"	1"	11300	5030	3760	3260		5160	5170	2820	2810	99109			11303
1"	1"	11310	5080	3760	3260			5170	2820	2810	99109			
1"	1-1/8"	18600	5020	36904	31904	56104			2820	2810	99109			
1"	1-1/4"	11000	5020	3790	3290	5110			2820	2810	99109	11001	11002	11003
1"	1-1/4"	11200	5080	3790	3290	5960			2820	2810	99109	11201		11203
1"	1-1/4"	11400	5020	3790	3290	5980			2820	2810	99109			11403
1"	1-1/4"	11500	5050	3790	3290	5110			2820	2810	99109	11501	11502	11503
1"	1-1/4"	11600	5020	3790	3290	5110			2400	2490	99109	11601		11603
1"	1-1/4"	11610	5020	3790	3290	5340			2400	2490	99109			
1"	1-1/4"	11700	5050	3660	3160	5110			2820	2810	99109	11701	11702	11703
1"	1-1/4"	11710	5080	3660	3160	5230			2820	2810	99109			
1"	1"	78310	5030	3550	3550		5160	5170	1680	1680	99109			
1"	1-1/4"	72610	5080	3540	3540	5230			1680	1680	99109	72611		
1"	1-1/4"	72730	5020	3540	3540	5110			1680	1680	99109	72731	72732	
1"	1-1/4"	78010	5020	3540	3540	5110			1680	1680	99109	78011	78012	

**INSWING**

All packs are supplied with series #4000 door hooks and mounting hardware.

**TOP HINGE ASSEMBLY**

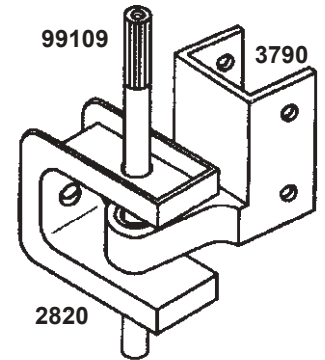

5110



5020



**BOTTOM HINGE ASSEMBLY**

PART #		CONTENTS										ALSO AVAILABLE IN			
Door Size	Post Size	Chrome Plated Zamac	Latch	Top Hinge	Bottom Hinge	Strike/ Keeper	One Pc Strike	Top Insert	Bottom Insert	Hinge Pin	Door Pull	Door Stop	Chrome Plated Brass	Polished Brass	Cast S.S.
1/2"	1/2"	29000	5020	3720	3220		5170	2380	2390	99585	6200				
1/2"	1"	28000	5020	3760	3260		5170	1540	1530	99585	6200				
7/8"	1-1/8"	28500	5020	36904	31904	5710		1540	1530	99109	6200				
7/8"	1-1/4"	27800	5020	3790	3290	5210		1540	1530	99109	6200		27801	27802	27803
7/8"	1-1/4"	27810	5020	3790	3290	5970		1540	1530	99109	6200				27813
7/8"	1-1/4"	27820	5020	3790	3290	5210		1540	1530	99109	6200	4120		27822	27823
7/8"	1-1/4"	27900	5050	3790	3290	5210		1540	1530	99109	5400	4120	27901	27902	27903
7/8"	1-1/4"	28100	5020	3790	3290	5210		1520	1510	99109	6200				
1"	1"	21300	5020	3760	3260		5170	2820	2810	99109	6200				21303
1"	1"	21310	6080	3760	3260		5170	2820	2810	99109	6200				
1"	1-1/8"	28600	5020	36904	31904	5710		2820	2810	99109	6200				
1"	1-1/4"	21000	5020	3790	3290	5210		2820	2810	99109	6200		21001	21002	21003
1"	1-1/4"	21200	5080	3790	3290	5960		2820	2810	99109	6200		21201		21203
1"	1-1/4"	21400	5020	3790	3290	5970		2820	2810	99109	6200	4120			
1"	1-1/4"	21500	5050	3790	3290	5210		2820	2810	99109	5400		21501	21502	21503
1"	1-1/4"	21600	5020	3790	3290	5210		2400	2490	99109	6200		21601		21603
1"	1-1/4"	21700	5050	3660	3160	5210		2820	2810	99109	5400		21701	21702	21703
1"	1-1/4"	21710	5080	3660	3160	5230		2820	2810	99109	5400				
1"	1"	78320	5020	3550	3550		5170	1680	1680	99109	6200				
1"	1-1/4"	72620	5080	3540	3540	5230		1680	1680	99109	6200		72621		
1"	1-1/4"	72740	5020	3540	3540	5210		1680	1680	99109	6200		72741	72742	
1"	1-1/4"	78020	5020	3540	3540	5210		1680	1680	99109	6200		78021	78022	

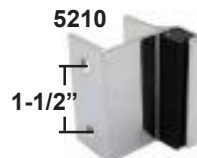
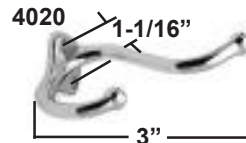
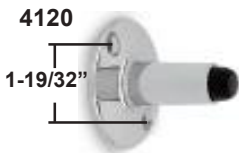
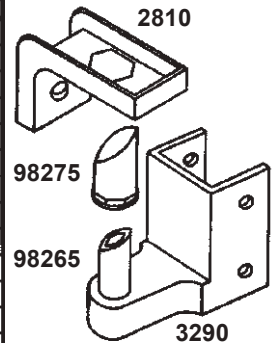

**OUTSWING**

All packs are supplied with series #4020 door hooks and mounting hardware.

**REPLACEMENT PACKS**

**63140**



**63130**



**TOP HINGE ONLY**

**PART # CONTENTS ALSO AVAILABLE IN**

DOOR SIZE	POST SIZE	CHROME PLATED ZAMAC	TOP HINGE	TOP INSERT	HINGE PIN	CAST STAINLESS STEEL
7/8"	1-1/4"	63020	3790	1540	99109	63023
1"	1-1/4"	63040	3790	2820	99109	63043
1"	1-1/4"	63060	3790	2400		
1"	1-1/4"	63080	4530	4540		
1"	1-1/4"	63100	3510			
1"	1-1/4"	63160	3540	1680		
1"	1-1/4"	63200	3910			
1"	1-1/4"	63220	3910			
1"	1-1/4"	63720	3630	4800		

**BOTTOM HINGE ONLY**

**PART # CONTENTS ALSO AVAILABLE IN**

DOOR SIZE	POST SIZE	CHROME PLATED ZAMAC	BOTTOM HINGE	BOTTOM INSERT	PINTLE	CAM	NUT & WASHER	CAST STAINLESS STEEL
7/8"	1-1/4"	63010	3290	1530	98265	98275	98305	63013
1"	1-1/4"	63030	3290	2810	98175	98245	98305	63033
1"	1-1/4"	63070	4040	4060	98175	98185	98305	
1"	1-1/4"	63090	3010		98175	98185	98305	
1"	1-1/4"	63160	3540	1680	89830	89820	98305	
1"	1-1/4"	63190	3410			97245	98305	
1"	1-1/4"	63210	3420			97275	97265	
1"	1-1/4"	63710	3130	4700	98175	98195	98305	

**TOP & BOTTOM HINGES**

**PART # CONTENTS ALSO AVAILABLE IN**

DOOR SIZE	POST SIZE	CHROME PLATED ZAMAC	TOP HINGE	TOP INSERT	BOTTOM HINGE	BOTTOM INSERT	PINTLE	CAM	HINGE PIN	CHROME PLATED BRASS	CAST STAINLESS STEEL
7/8"	1-1/4"	63120	3790	1540	3290	1530	98265	98275	99109	63121	63123
1"	1"	63150	3760	2820	3260	2810	98175	98245	99109		63153
1"	1-1/4"	63130	3790	2820	3290	2810	98175	98245	99109	63131	63133
1"	1-1/4"	63140	3510		3010		98175	98185	98584		63143

**Surface Mounted Door Packs**

**Inswing**

All packs are supplied with series #4000 door hooks and mounting hardware

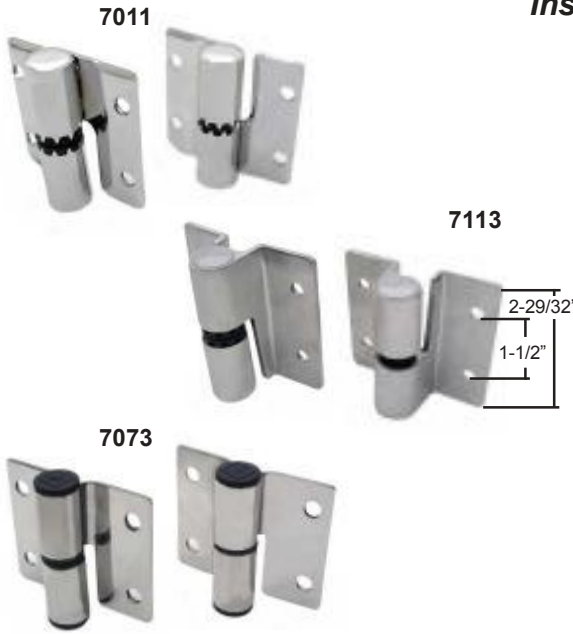

CHROME PLATED ZAMAC					CONTENTS				ALSO AVAILABLE IN	
Door Size	Post Size	Part #	Swing of Door	Latch	Hinge Set	Strike/ Keeper	One Pc Strike	One Pc Keeper	Chrome Plated Brass	Polished Brass
1/2"	1/2"	20510	LH-IN	5030	7021		5170	5160		20512
1/2"	1/2"	20520	RH-IN	5030	7011		5170	5160		
1/2"	3/4"	20410	LH-IN	5020	7021		5170	5160		
1/2"	3/4"	20420	RH-IN	5020	7011		5170	5160		
3/4"	3/4"	20450	LH-IN	5030	7021		5170	5160	20451	20452
3/4"	3/4"	20460	RH-IN	5030	7011		5170	5160	20461	20462
3/4"	1"	20550	LH-IN	5020	7021		5170	5160	20551	
3/4"	1"	20560	RH-IN	5020	7011		5170	5160	20561	
3/4"	1"	70500	LH-IN	5050	7021		5170	5160		70502
3/4"	1"	70510	RH-IN	5050	7011		5170	5160		70512
3/4"	1"	20610	LH-IN	5020	7083		5170	5160		
3/4"	1"	20620	RH-IN	5020	7073		5170	5160		
1"	1"	20650	LH-IN	5020	7123	5620				
1"	1"	20660	RH-IN	5020	7113	5620				
1"	1"		LH-IN	5701	7021		5171		20801	
1"	1"		RH-IN	5701	7011		5171		20811	
1"	1-1/4"	20100	LH-IN	5020	7021	5110			20101	20102
1"	1-1/4"	20110	RH-IN	5020	7011	5110			20111	20112

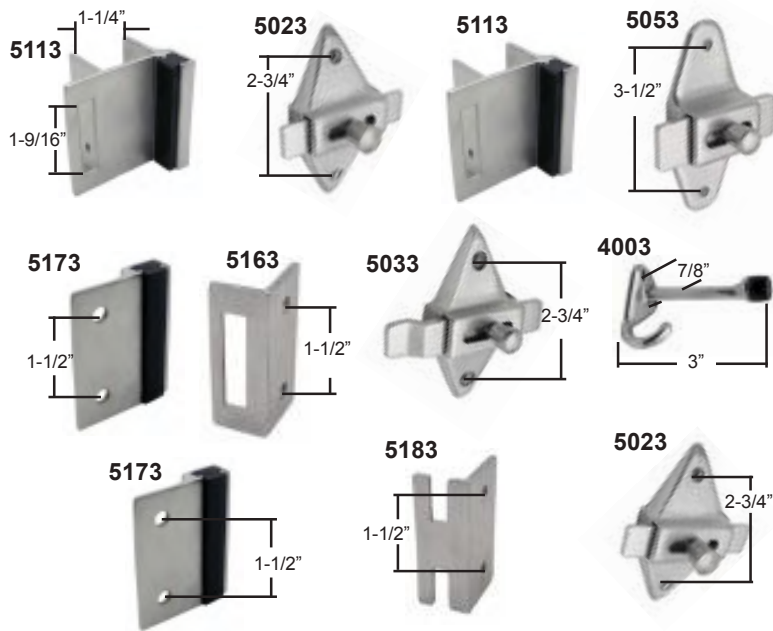

CAST STAINLESS STEEL					CONTENTS					
Door Size	Post Size	Part #	Swing of Door	Latch	Hinge Set	Strike/ Keeper	One Pc Strike	One Pc Keeper		
1/2"	3/4"	70543	LH-IN	5023	7123		5173	5163		
1/2"	3/4"	70553	RH-IN	5023	7113		5173	5163		
3/4"	3/4"	20453	LH-IN	5033	7123		5173	5163		
3/4"	3/4"	20463	RH-IN	5033	7113		5173	5163		
3/4"	3/4"	20943	LH-IN	5033	7423		5173	5163		
3/4"	3/4"	20953	RH-IN	5033	7413		5173	5163		
3/4"	1"	20553	LH-IN	5023	7083	5623				
3/4"	1"	20563	RH-IN	5023	7073	5623				
3/4"	1"	70503	LH-IN	5050	7083		5170	5160		
3/4"	1"	70513	RH-IN	5050	7073		5170	5160		
3/4"	1"	20613	LH-IN	5023	7043	5113				
3/4"	1"	20623	RH-IN	5023	7033	5113				
1"	1"	20653	LH-IN	5033	7123	5623				
1"	1"	20663	RH-IN	5033	7113	5623				
1"	1-1/4"	20903	LH-IN	5023	7423		5173	5163		
1"	1-1/4"	20913	RH-IN	5023	7413		5173	5163		
1"	1-1/4"	20103	LH-IN	5023	7083	5113				
1"	1-1/4"	20113	RH-IN	5023	7073	5113				
1"	1-1/4"	20123	LH-IN	5023	7123	5113				
1"	1-1/4"	20133	RH-IN	5023	7113	5113				

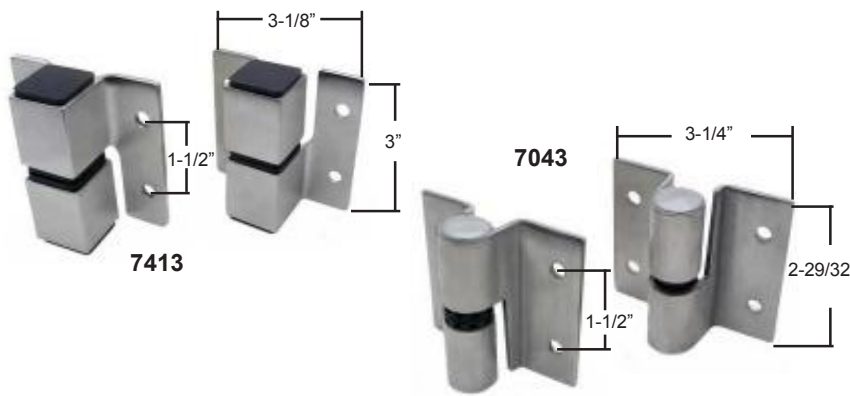

STAMPED STAINLESS STEEL					CONTENTS					
Door Size	Post Size	Part #	Swing of Door	Latch	Hinge Set	One Pc Strike	One Pc Keeper			
3/4"	3/4"	20459	LH-IN	6309	7123	6329	6319			
3/4"	3/4"	20469	RH-IN	6309	7113	6329	6319			
3/4"	3/4"	20949	LH-IN	6309	7083	6369	6499			
3/4"	3/4"	20959	RH-IN	6309	7073	6369	6499			
3/4"	1"	20019	LH-IN	6409	7043		6539			
3/4"	1"	20029	RH-IN	6409	7033		6539			
3/4"	1"	20559	LH-IN	6309	7083	6369	6499			
3/4"	1"	20569	RH-IN	6309	7073	6369	6499			
7/8"	1-1/4"	21909	LH-IN	6309	7423	6389	6499			
7/8"	1-1/4"	21919	RH-IN	6309	7413	6389	6499			
1"	1"	20109	LH-IN	6309	7089	6449	6499			
1"	1"	20119	RH-IN	6309	7079	6449	6499			

**Surface Mounted Door Packs**

All packs are supplied with series #4020 door hooks and mounting hardware

**Outswing**

CHROME PLATED ZAMAC				CONTENTS				ALSO AVAILABLE IN		
DOOR SIZE	POST SIZE	PART #	SWING OF DOOR	LATCH	HINGE SET	STRIKE/KEEPER	ONE PC. STRIKE	DOOR PULL	CHROME PLATED BRASS	POLISHED BRASS
1/2"	1/2"	20530	LH-OUT	5020	7011		5170	6200		
1/2"	1/2"	20540	RH-OUT	5020	7021		5170	6200		
1/2"	3/4"	20430	LH-OUT	5020	7011		5170	6200		
1/2"	3/4"	20440	RH-OUT	5020	7021		5170	6200		
3/4"	3/4"	20470	LH-OUT	5020	7011		5170	6200		20472
3/4"	3/4"	20480	RH-OUT	5020	7021		5170	6200		20482
3/4"	1"	20570	LH-OUT	5020	7011		5170	6200	20571	
3/4"	1"	20580	RH-OUT	5020	7021		5170	6200	20581	
3/4"	1"	70520	LH-OUT	5020	7011		5170	5400		70522
3/4"	1"	70530	RH-OUT	5020	7021		5170	5400		70532
3/4"	1"	20630	LH-OUT	5020	7073		5170	6200		
3/4"	1"	20640	RH-OUT	5020	7083		5170	6200		
1"	1"	20670	LH-OUT	5020	7113		5170	6200		
1"	1"	20680	RH-OUT	5020	7123		5170	6200		
1"	1"		LH-OUT	5701	7011		5171	5401	20821	
1"	1"		RH-OUT	5701	7021		5171	5401	20831	
1"	1-1/4"	20200	LH-OUT	5020	7011	5210		6200	20201	20202
1"	1-1/4"	20210	RH-OUT	5020	7021	5210		6200	20211	20212

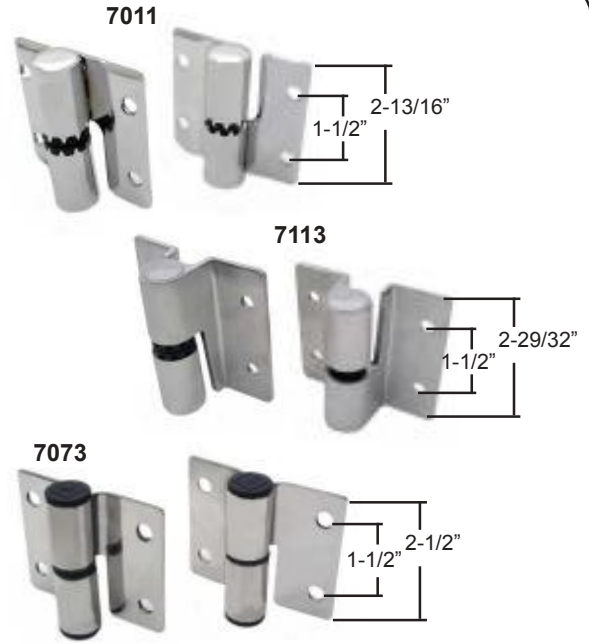

CAST STAINLESS STEEL				CONTENTS					
DOOR SIZE	POST SIZE	PART #	SWING OF DOOR	LATCH	HINGE SET	STRIKE/KEEPER	ONE PC. STRIKE	DOOR PULL	DOOR STOP
1/2"	3/4"	70563	LH-OUT	5023	7113		5173	6203	
1/2"	3/4"	70573	RH-OUT	5023	7123		5173	6203	
3/4"	3/4"	20473	LH-OUT	5023	7113		5173	6203	
3/4"	3/4"	20483	RH-OUT	5023	7123		5173	6203	
3/4"	3/4"	20963	LH-OUT	5023	7413		5173	6203	
3/4"	3/4"	20973	RH-OUT	5023	7423		5173	6203	
3/4"	1"	20573	LH-OUT	5023	7073	5723		6203	
3/4"	1"	20583	RH-OUT	5023	7083	5723		6203	
3/4"	1"	70523	LH-OUT	5050	7073		5170	5400	
3/4"	1"	70533	RH-OUT	5050	7083		5170	5400	
3/4"	1"	20633	LH-OUT	5023	7033	5213		6203	
3/4"	1"	20643	RH-OUT	5023	7043	5213		6203	
1"	1"	20673	LH-OUT	5023	7113	5723		6203	
1"	1"	20683	RH-OUT	5023	7123	5723		6203	
1"	1-1/4"	20923	LH-OUT	5023	7413		5173	6203	4123
1"	1-1/4"	20933	RH-OUT	5023	7423		5173	6203	4123
1"	1-1/4"	20203	LH-OUT	5023	7073	5213		6203	
1"	1-1/4"	20213	RH-OUT	5023	7083	5213		6203	
1"	1-1/4"	20223	LH-OUT	5023	7113	5213		6203	4123
1"	1-1/4"	20233	RH-OUT	5023	7123	5213		6203	4123

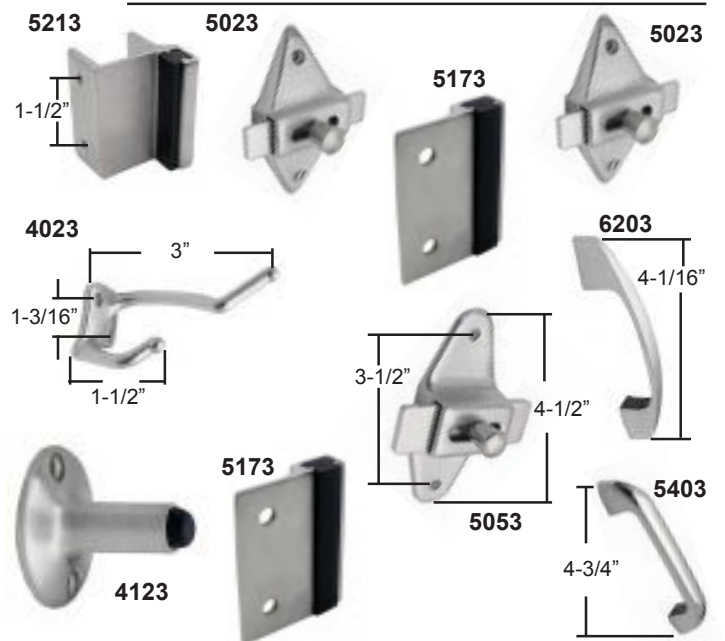

STAMPED STAINLESS STEEL				CONTENTS					
DOOR SIZE	POST SIZE	PART #	SWING OF DOOR	LATCH	HINGE SET	STRIKE/KEEPER	DOOR PULL	DOOR STOP	
3/4"	3/4"	20479	LH-OUT	6309	7113	6329	6419		
3/4"	3/4"	20489	RH-OUT	6309	7123	6329	6419		
3/4"	3/4"	20969	LH-OUT	6309	7413	6379	6203		
3/4"	3/4"	20979	RH-OUT	6309	7423	6379	6203		
3/4"	1"	20039	LH-OUT	6309	7033	6569	6419	4129	
3/4"	1"	20049	RH-OUT	6309	7043	6569	6419	4129	
3/4"	1"	20579	LH-OUT	6309	7089	6379	6419		
3/4"	1"	20589	RH-OUT	6309	7079	6379	6419		
7/8"	1-1/4"	21929	LH-OUT	6309	7413	6399	6419		
7/8"	1-1/4"	21939	RH-OUT	6309	7423	6399	6419		
1"	1"	20209	LH-OUT	6309	7079	6559	6419		
1"	1"	20219	RH-OUT	6309	7089	6559	6419		

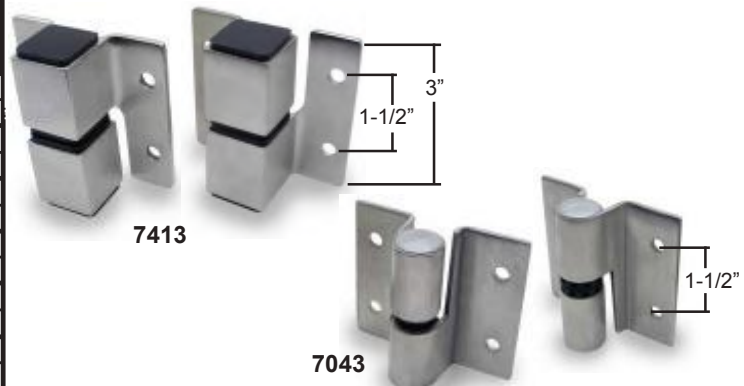



**Prepackaged Hardware**

**TWO EAR PANEL PACKS**

PANEL SIZE	PART# CONTENTS			ALSO AVAILABLE IN				
	CHROME PLATED ZAMAC	WALL BRACKET	"U" BRACKET	CHROME PLATED BRASS	POLISHED BRASS	CAST STAINLESS STEEL	ALUMINUM EXTRUSION	STAMPED STAINLESS STEEL
1/2"	15000	1560	1870			15003		15009
3/4"	15010	1620	1890			15013		15019
7/8"	15020	1630	1900	15021	15022	15023		15029
1"	15030	1750	1910	15031	15032	15033	15034	15039
1-1/4"	15040	1830	1940		15042	15043		15049

THREE BRACKET PACKS

1/2"	15170	1560	1870			15173	15174	15179
3/4"	15160	1620	1890			15163		15169
7/8"	15150	1630	1900	15151	15152	15153		15159
1"	15980	1750	1910			15983		

1-1/4" Inquire About Special Request Orders

**ONE EAR PANEL PACKS**

PANEL SIZE	PART# CONTENTS			ALSO AVAILABLE IN				
	CHROME PLATED ZAMAC	WALL BRACKET	"U" BRACKET	CHROME PLATED BRASS	POLISHED BRASS	CAST STAINLESS STEEL	ALUMINUM EXTRUSION	STAMPED STAINLESS STEEL
1/2"	15110	1570	1870			15113		15119
3/4"	15100	1640	1890			15103		15109
7/8"	15090	1650	1900	15091	15092	15093		15099
1"	15050	1760	1910	15051	15052	15053	15054	15059
1-1/8"	15130	18204						
1-1/4"	15140	1840	1940	15141	15142	15143	15144	15149

THREE BRACKET PACKS

1/2"		1570	1870			15573		15579
3/4"		1640	1890			715103		715109
7/8"	715090	1650	1900					
1"	15080	1760	1910	15081	15082	15083	15084	15089

1-1/8" Inquire About Special Request Orders

1-1/4" Inquire About Special Request Orders

**ONE EAR PILASTER PACKS**

PANEL SIZE	PART# CONTENTS			ALSO AVAILABLE IN			
	CHROME PLATED ZAMAC	WALL BRACKET	CHROME PLATED BRASS	POLISHED BRASS	CAST STAINLESS STEEL	ALUMINUM EXTRUSION	STAMPED STAINLESS STEEL
1/2"	15190	1570			15193		15199
3/4"	15810	1640			15813		15819
7/8"	15820	1650	15821	15822	15823		15829
1"	15250	1760	15251	15252	15253	15254	15259
1-1/8"	15210	18204					15219
1-1/4"	15230	1840	15231	15232	15233	15234	15239
1-1/4"	15240	1850	15241	15242	15243		15249

**TWO EAR PILASTER PACKS**

PANEL SIZE	PART# CONTENTS			ALSO AVAILABLE IN			
	CHROME PLATED ZAMAC	WALL BRACKET	CHROME PLATED BRASS	POLISHED BRASS	CAST STAINLESS STEEL	ALUMINUM EXTRUSION	STAMPED STAINLESS STEEL
1/2"	15200	1560			15203	15204	15209
3/4"	15840	1620			15843		15849
7/8"	15850	1630	15851	15852	15853		15859
1"	15280	1750	15281	15282	15283	15284	15289
1-1/4"	15220	1830	15221	15222	15223		15229
1-1/4"	15870	1810	15871		15873		15879

**Panel & Pilaster Packs**

All packs are supplied with mounting hardware

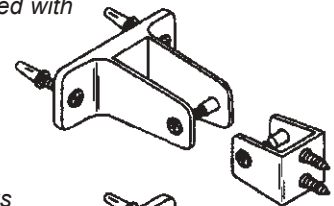

Two ear panel packs

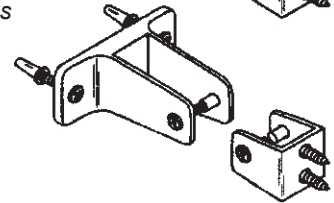

One ear panel packs

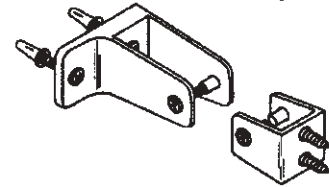
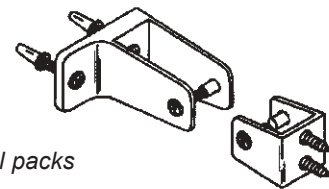

One ear pilaster packs

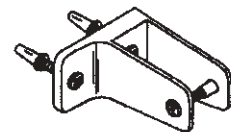
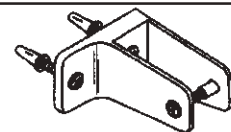

Two ear pilaster packs

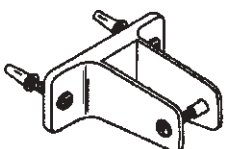

**Alcove, Urinal, Angle Bracket, Headrail Packs**

All packs are supplied with mounting hardware

Alcove Packs (Two Ear)

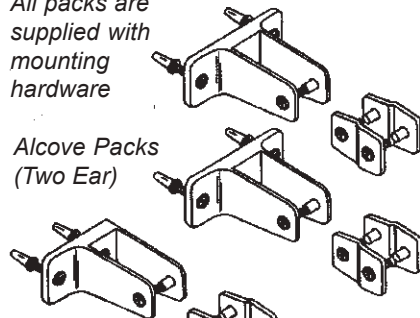

Alcove Packs (One Ear)

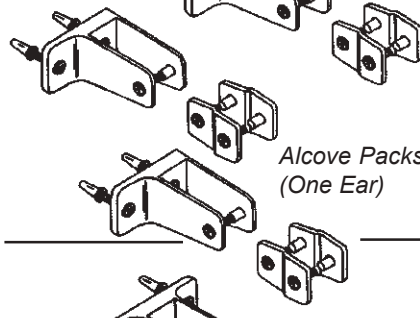

Urinal Screen Packs

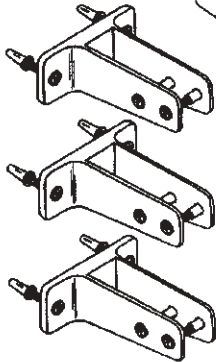

Angle Bracket Packs

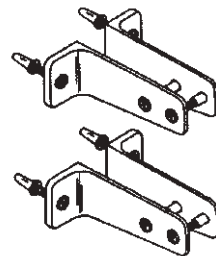

PANEL SIZE	POST SIZE	PART#				CONTENTS				ALSO AVAILABLE IN					BRACKET TYPE
		CHROME PLATED ZAMAC	WALL BRACKET	ALCOVE CLIP	HEADRAIL BRACKET	CHROME PLATED BRASS	POLISHED BRASS	CAST STAINLESS STEEL	ALUMINUM EXTRUSION	STAMPED STAINLESS STEEL					
ALL 1/4" Offsets		15300		8340		15301	15302	15303		15309					
1/2"	3/4"	15350	1560	8340				15353		15359				2-EAR	
3/4"	3/4"	15660	1623	8369				15663		15669				2-EAR	
3/4"	1"	15310	1620	8340				15313		15319				2-EAR	
3/4"	1"	15680	1640	8340										1-EAR	
7/8"	1"	15320	1630	8340		15321	15322	15323		15329				2-EAR	
7/8"	1"	15380	1630	8340	2170									2-EAR	
7/8"	1"	15690	1650	8340										1-EAR	
1"	1"	15670	1760	8369						15679				1-EAR	
1"	1-1/4"	15330	1750	8340		15331	15332	15333	15334	15339				2-EAR	
1"	1-1/4"	15360	1760	8340		15361	15362	15363	15364	15369				1-EAR	
1"	1-1/4"	15370	1750	1550										2-EAR	

**URINAL SCREEN PACKS**

SCREEN SIZE	PART#		CONTENTS				ALSO AVAILABLE IN			BRACKET TYPE
	CHROME PLATED ZAMAC	WALL BRACKET	CHROME PLATED BRASS	POLISHED BRASS	CAST STAINLESS STEEL	ALUMINUM EXTRUSION	STAMPED STAINLESS STEEL			
ALL	15470	1320	15471	15472	15473		15479	ANGLE X-LONG		
1/2"	15390	1480			15393		15399			
3/4"	15410	1590			15413		15419			
7/8"	15420	1600	15421	15422	15423		15429			
1"	15430	1610	15431	15432	15433	15434	15439			
1"	15440	1280	15441	15442	15443		15449	2-PC X-LONG		
1"	15510	1280	15511	15512	15513		15519	X-LONG		
1-1/4"	15450	107720	15451	15452	15453		15459			
1-1/4"	15460	1330					15469	2-PC X-LONG		
1-1/4"	15500	1330					15509	X-LONG		

**ANGLE BRACKET PACKS**

PANEL SIZE	PART#		CONTENTS			ALSO AVAILABLE IN		
	CHROME PLATED ZAMAC	WALL BRACKET	CHROME PLATED BRASS	POLISHED BRASS	CAST STAINLESS STEEL	STAMPED STAINLESS STEEL		
ALL	15480	1320 (2-SET) X-LONG	15481		15483	15489		
ALL	15490	1320 (1-SET) X-LONG	15491	15492	15493	15499		
ALL	15520	1860 (2-SET)	15521	15522	15523	15529		
ALL	15530	1860 (1-SET)	15531	15532	15533	15539		

**HEADRAIL CORNER PACKS**

PANEL SIZE	PART #		CONTENTS		ALSO AVAILABLE IN		
	CHROME PLATED ZAMAC	U-BRACKET	END PLUG	CAST STAINLESS STEEL	ALUMINUM EXTRUSION	STAMPED STAINLESS STEEL	
ALL	15800	1910	6675	15803	15804	15809	

**HEADRAIL MOUNTING PACKS**

SCREEN SIZE	PART #		CONTENTS		ALSO AVAILABLE IN	
	CHROME PLATED ZAMAC	MOUNTING BRACKET	END PLUG	CAST STAINLESS STEEL	STAMPED STAINLESS STEEL	
ALL	15790	1350 (3-PC)	6675 (1-PC)	15793	15799	
1"	15700	1350 (3-PC)	6715 (2-PC)	15703	15709	
1"	15710	2150 (1-PC)	6660 (1-PC)			
1/2" to 1"	15720	2150 (1-PC)	6670 (1-PC)		15729	
1/2" to 1"	15730	2150 (2-PC)			15739	
1-1/4"	15740	2170 (1-PC)	6675 (1-PC)			
1-1/4"	15750	2170 (2-PC)				

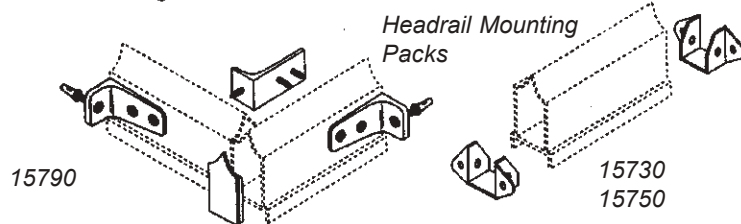
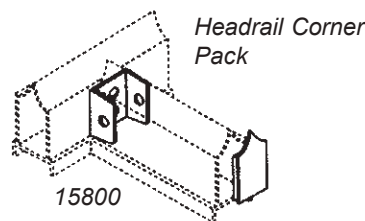
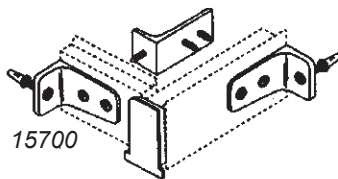

**Castings**

**All Brackets At 1-1/2"**

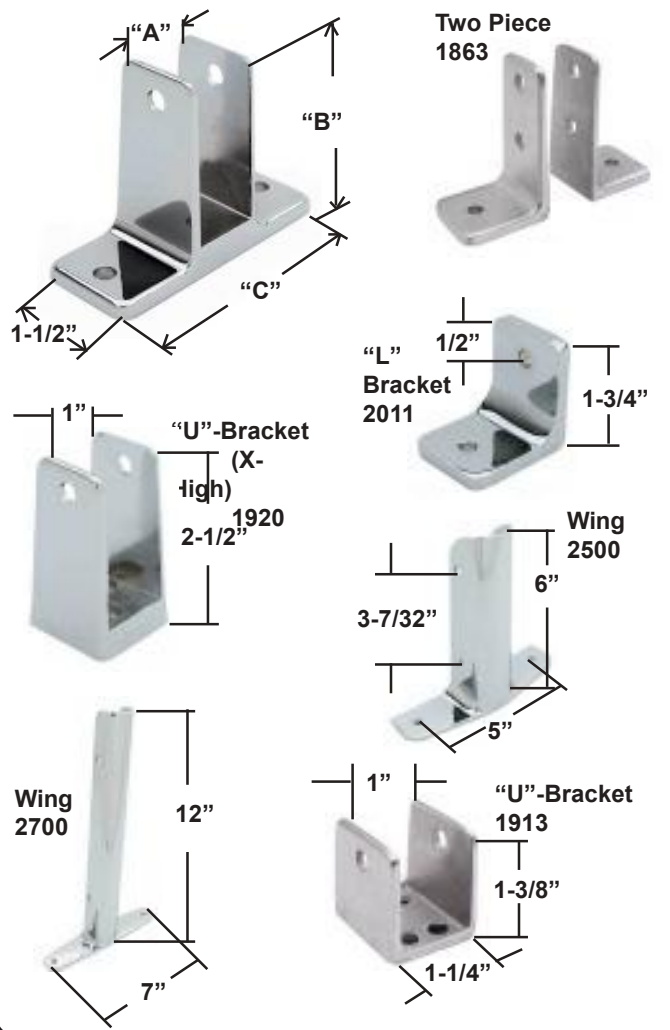

"A" PANEL SIZE	"B" BRACKET HEIGHT	"C" BASE WIDTH	DESCRIPTION	CHROME PLATED ZAMAC	CHROME PLATED BRASS	POLISHED BRASS	CAST STAINLESS STEEL
<b>TWO EAR BRACKETS</b>							
1/2"	2-1/2"	2-27/32"		1560			1563
3/4"	2-1/2"	3"		1620			1623
7/8"	2-1/2"	3-1/2"		1630	1631	1632	1633
1"	2-1/2"	4"		1750	1751	1752	1753
1-1/4"	2-1/2"	4"		1830	1831	1832	1833
<b>ONE EAR BRACKETS</b>							
1/2"	2-1/2"	1-3/4"		1570			1573
3/4"	2-1/2"	2"		1640		1642	1643
7/8"	2-1/2"	2-3/32"		1650	1651	1652	1653
1"	2-1/2"	2-21/32"		1760	1761	1762	1763
1-1/8"	2-1/2"	2-3/4"	With Spacers	18204			
1-1/4"	2-1/2"	2-3/4"		1840	1841	1842	1843
<b>MINI BRACKETS</b>							
ALL	1-3/4"	1-3/8"	Two Piece	1580			
1-1/4"	1-3/4"	4"	Two Ear	1810			1813
1-1/4"	1-3/4"	2-3/4"	One Ear	1850		1852	1853
<b>X-HIGH BRACKETS</b>							
1"	3-1/2"	4"	Two Ear	1260			
1"	3-1/2"	2-21/32"	One Ear	1270			
1-1/4"	3-1/2"	4"	Two Ear	1300			
1-1/4"	3-1/2"	2-27/32"	One Ear	1310			
<b>URINAL SCREEN BRACKETS</b>							
1/2"	2-1/2"	1-3/4"	One Ear	1470			
1/2"	2-1/2"	2-27/32"	Two Ear	1480			1483
3/4"	2-1/2"	3"	Two Ear	1590			1593
7/8"	2-1/2"	3-1/2"	Two Ear	1600	1601	1602	1603
1"	2-1/2"	4"	Two Ear	1610	1611	1612	1613
1"	3-1/2"	2-21/32"	One Ear X-High	1660			
1"	3-1/2"	4"	Two Ear X-High	1280	1281	1282	1283
1-1/4"	2-1/2"	4"	Two Ear	107720			107723
1-1/4"	3-1/2"	4"	Two Ear X-High	1330			
<b>WING BRACKETS</b>							
1"	12"	7"		2700			
1-1/4"	6"	6-1/4"		2500			
<b>"U" BRACKETS</b>							
1/2"	1-3/8"	3/4"		1870			1873
3/4"	1-3/8"	1"		1890			1893
7/8"	1-3/8"	1-1/8"		1900	1901	1902	1903
1"	1-3/8"	1-1/4"		1910	1911	1912	1913
1-1/4"	1-3/8"	1-1/2"		1940			
<b>"U" BRACKETS X-HIGH</b>							
1"	2-1/2"	1-1/4"		1920			
1-1/4"	2-1/2"	1-9/16"		1950			
<b>TWO PIECE "L" BRACKETS</b>							
ALL	1-3/4"	1-3/8"	Mini (1) Hole	1580			
ALL	2-1/2"	1-1/2"	Standard (2) Hole	1860	1861	1862	1863
ALL	3-1/2"	1-1/2"	X-High (2) Hole	1320	1321	1322	1323
<b>ANGLE "L" BRACKETS (SINGLE)</b>							
ALL	1-3/4"	1-3/4"	Mini		2011	2012	2013

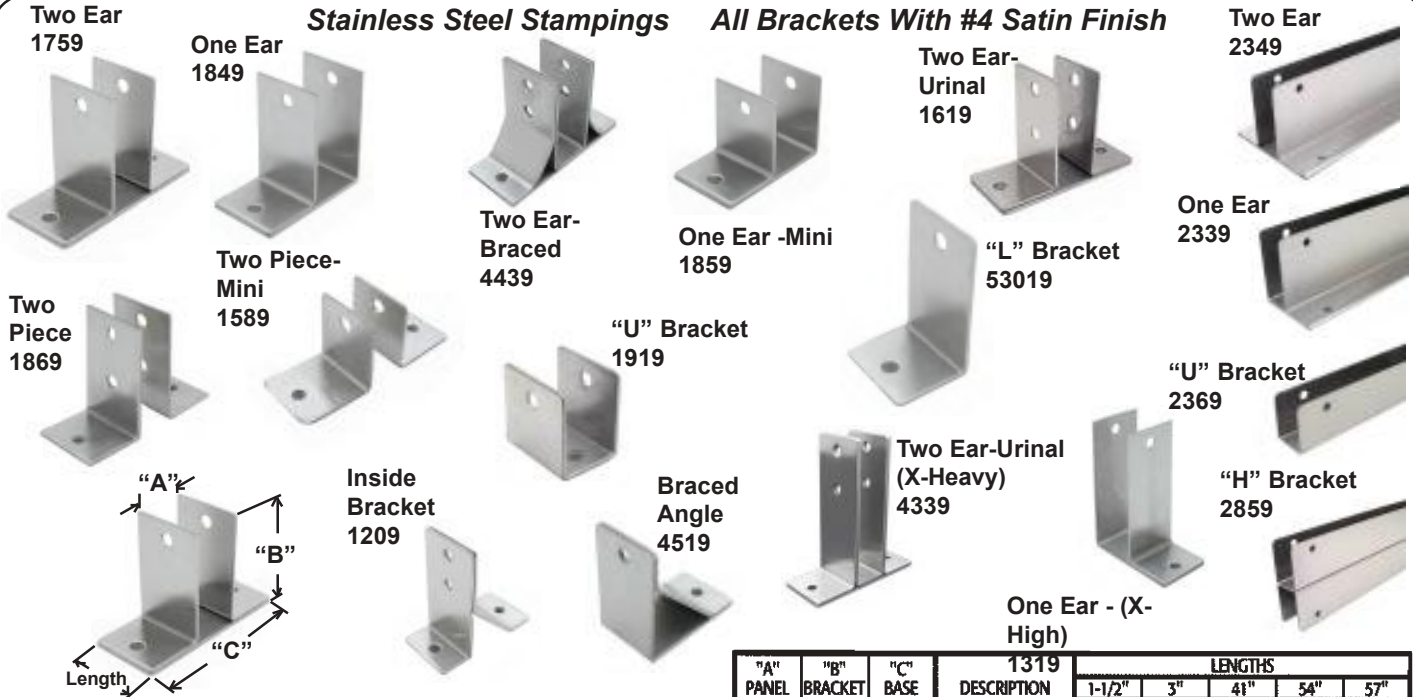

"A" PANEL SIZE	"B" BRACKET HEIGHT	"C" BASE WIDTH	DESCRIPTION	LENGTHS				
				1-1/2"	3"	41"	54"	57"
TWO EAR BRACKETS								
1/2"	2-1/2"	3-3/16"		1569	2209	2059		2679
3/4"	2-1/2"	3-13/32"		1629	2229			2089
7/8"	2-1/2"	3-9/16"		1639	2249			
1"	2-1/2"	3-11/16"		1759	2269	2609	2869	2349
1-1/8"	2-1/2"	3-13/16"		1779	2389			
1-1/4"	2-1/2"	3-15/16"		1839	2289			
1-1/2"	2-1/2"	3-29/32"		1709				
1"	2-5/8"	4"	Braced Two Ear	4439				
ONE EAR BRACKETS								
1/2"	2-1/2"	1-29/32"		1579	2219		2919	2099
3/4"	2-1/2"	2-5/32"		1649	2239			2079
7/8"	2-1/2"	2-5/16"		1659	2259			
1"	2-1/2"	2-13/32"		1769	2279		2879	2339
1-1/8"	2-1/2"	2-17/32"		1829				
1-1/4"	2-1/2"	2-11/16"		1849	2299			2359
ALL	2-7/8"	2-29/32"	Inside Wall Bracket	1209				
MINI BRACKETS								
ALL	1-5/8"	1-5/8"	(2-Pc.) Set	1589				
3/4"	1-1/2"	2-5/32"	One Ear	1679				
1"	1-1/2"	2-13/32"	One Ear	1749				
1-1/4"	1-5/8"	3-15/16"	Two Ear	1819				
1-1/4"	1-3/4"	2-11/16"	One Ear	1859				4359
ONE EAR X-HIGH BRACKETS								
3/4"	3-1/2"	2-5/32"		1259				
1"	3-1/2"	2-13/32"		1279				
1-1/4"	3-1/2"	2-11/16"		1319				
TWO EAR X-HIGH BRACKETS								
3/4"	3-1/2"	3-13/32"		1249				
1"	3-1/2"	3-11/16"		1269				
1-1/4"	3-1/2"	3-15/16"		1309				
URINAL SCREEN BRACKETS								
1/2"	2-1/2"	1-29/32"	One Ear	1479				
1/2"	2-1/2"	3-3/16"	Two Ear	1489				
3/4"	2-1/2"	2-5/32"	One Ear	1699				
3/4"	2-1/2"	3-13/32"	Two Ear	1599				
7/8"	2-1/2"	3-9/16"	Two Ear	1609				
1"	2-1/2"	3-11/16"	Two Ear	1619				

"A" PANEL SIZE	"B" BRACKET HEIGHT	"C" BASE WIDTH	DESCRIPTION	1319 LENGTHS				
				1-1/2"	3"	41"	54"	57"
TWO EAR URINAL SCREEN X-HEAVY								
1/2"	4"	3-5/8"		4309				
3/4"	4"	3-7/8"		4319				
7/8"	4"	4"		4329				
1"	4"	4-1/8"		4339				
1-1/4"	4"	4-3/8"		4349				
URINAL SCREEN X-HIGH								
1"	3-1/2"	2-13/32"	One Ear	1669				
7/8"	3-1/2"	3-17/32"	Two Ear	1239				
1"	3-1/2"	3-11/16"	Two Ear	1289				
1-1/4"	3-1/2"	3-15/16"	Two Ear	1339				
"U" BRACKETS								
1/2"	1-1/2"	11/16"		1879	2989	2039		2669
3/4"	1-1/2"	15/16"		1899			4589 (53")	2069
7/8"	1-1/2"	1-1/16"		1909				
1"	1-1/2"	1-3/16"		1919	2309	101309	2799	2369
1-1/8"	1-1/2"	1-9/32"		1939				
1-1/4"	1-1/2"	1-13/32"		1949				
1-1/2"	1-1/2"	1-11/16"		1889				
"U" BRACKETS X-HIGH								
1/2"	2-1/2"	11/16"		1999	2189			
3/4"	2-1/2"	15/16"		1989	2319			
7/8"	2-1/2"	1-1/16"		1979	2199			
1"	2-1/2"	1-3/16"		1929	2329			
1-1/8"	2-1/2"	1-5/16"		1969	103719			
1-1/4"	2-1/2"	1-7/16"		1959	2999			
TWO PIECE BRACKETS								
ALL	2-1/2"	1-1/4"	(2 Hole)	1869				
ALL	3-1/2"	1-5/16"	(2 Hole) X-High	1329				
ANGLE "L" BRACKETS								
ALL	2"	13/16"	3/4" Length / 12 Gauge	2809				
ALL	1-5/8"	1-5/8"		2019				
ALL	2-1/2"	1-5/16"		53019				2689
ALL	3-1/2"	1-5/16"		1359				
ALL	3-1/2"	3-1/2"	Braced Angle Bracket	4519				
"H" BRACKET								
1"	3-1/2"	1-1/8"	Riveted & Welded				2859	
HINGED BRACKETS (see back cover)								
1"	2-9/16"	3"	Uses (1) #2329		111359			
1-1/4"	2-9/16"	3"	Uses (1) #2999		111369			



**Aluminum Extrusions**



Two Ear  
2344



One Ear  
2334



'U' Bracket  
2364



'L' Bracket  
2684



'H' Bracket  
2858

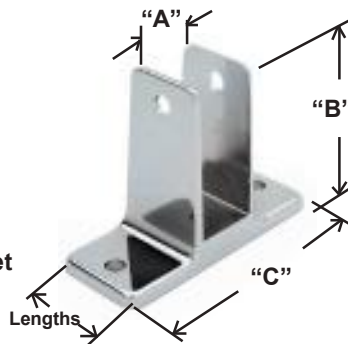

All Parts "T-6063-T5"  
Extruded Aluminum  
With "Clear Anodized"  
Finish



Two Ear  
1754



One Ear  
1764



Two Ear - Urinal  
1614



'U' Bracket - (X-Long)  
2304



'U' Bracket  
1914



'L' Bracket  
1864



Two Ear - (X-Long)  
2264



One Ear - (X-Long)  
2274



'H' Bracket  
1734

"A" PANEL SIZE	"B" HEIGHT	"C" BASE WIDTHS	LENGTHS					
			1-1/2"	3"	41"	54"	57"	57-1/2"
TWO EAR BRACKETS								
1/2"	2-3/4"	2-27/32"	1564	2204	2054		4174	2674
3/4"	2-3/4"	3-13/32"			4604			2084
1"	2-3/4"	3-3/4"	1754	2264	2888	2868		2344
ONE EAR BRACKETS								
1/2"	2-3/4"	1-31/32"					2094	4394
3/4"	2-3/4"	2-7/32"	1644	109284			2074	4364
1"	2-3/4"	2-5/8"	1764	2274		2878		2334
1-1/4"	2-3/4"	2-5/8"	1844	2294				2354
1-1/4"	1-3/4"	2-5/8"						4354 (mini)
URINAL SCREEN BRACKET								
1"	2-3/4"	3-3/4"	1614					
'U' BRACKETS								
1/2"	1-3/8"	3/4"	1874	2984	2034		4184	2664
3/4"	1-3/8"	1"				4584 (53")		2064
1"	1-3/8"	1-5/16"	1914	2304	101304	2794		2364
1"	2-3/4"	1-1/4"		2324 (x-high)				
'L' BRACKET								
ALL	2-3/4"	1-3/8"	1864 (2pc)					2684
'H' BRACKET								
1"	2-1/2"	1-1/4"	1724	1734		2858		

	CHROME PLATED BRASS	POLISHED BRASS	CAST STAINLESS STEEL	STAMPED STAINLESS STEEL	DESCRIPTION	FINISH	HINGE THICKNESS
#	7011	7012			RH-IN or LH-OUT (3" Height)		
#	7131	7132			Top Hinge Only RH-IN or LH-OUT	Polished	3/32"
#	7141	7142			Bottom Hinge Only RH-IN or LH-OUT		
#	7021	7022			LH-IN or RH-OUT (3" Height)		
#	7151	7152			Top Hinge Only LH-IN or RH-OUT	Polished	3/32"
#	7161	7162			Bottom Hinge Only LH-IN or RH-OUT		
				7033	RH-IN or LH-OUT (3" Height)	Satin	3/32"
				7043	LH-IN or RH-OUT (3" Height)		
				7053	RH-IN or LH-OUT (3" Height)	Satin	1/8"
				7063	LH-IN or RH-OUT (3" Height)		
*				7073	RH-IN or LH-OUT (2-1/2" Height)	Polished	3/32"
*				7083	LH-IN or RH-OUT (2-1/2" Height)		
*				7079	RH-IN or LH-OUT (2-1/2" Height)	Satin	3/32"
*				7089	LH-IN or RH-OUT (2-1/2" Height)		
*				7093	RH-IN or LH-OUT (2-7/8" Height)	Satin	1/8"
*				7103	LH-IN or RH-OUT (2-7/8" Height)		
				8169	RH-IN or LH-OUT (3-3/8" Height)	Satin	1/8"
				8179	LH-IN or RH-OUT (3-3/8" Height)		
				7113	RH-IN or LH-OUT (3" Height)	Satin	1/8"
				7133	Top Hinge Only RH-IN or LH-OUT		
				7143	Bottom Hinge Only RH-IN or LH-OUT		
				7123	LH-IN or RH-OUT (3" Height)	Satin	1/8"
				7153	Top Hinge Only LH-IN or RH-OUT		
				7163	Bottom Hinge Only LH-IN or RH-OUT		
Three Hinge Sets - Two Tops and One Bottom							
				7553	RH-IN or LH-OUT of 7113		
				7563	LH-IN or RH-OUT of 7123		
				7883	RH-IN or LH-OUT of 7093		
				7893	LH-IN or RH-OUT of 7103		
Spring Adjustable							
				8643	RH-IN/OUT or LH-IN/OUT (4" Height)	Polished	3/32"
				8649	RH-IN/OUT or LH-IN/OUT (4" Height)	Satin	
				8653	RH-IN/OUT or LH-IN/OUT (5" Height)	Polished	3/32"
				8659	RH-IN/OUT or LH-IN/OUT (5" Height)	Satin	
Square Barrel Hinges							
				7413	RH-IN or LH-OUT (3" Height)	Satin	1/8"
				7423	LH-IN or RH-OUT (3" Height)		
Locker Hinge							
				7719	RH-OUT or LH-OUT (2-3/4" Height)	Satin	3/32"

# THREE HINGE SETS RECOMMENDED ON HANDICAPPED, OVERSIZED OR OUTSWING DOORS.  
TWO HINGE SETS NOT RECOMMENDED FOR DOORS OVER 50 LBS.  
THREE HINGE SETS NOT RECOMMENDED FOR DOORS OVER 70 LBS.  
\* HANDEDNESS OF HINGES CANNOT BE CHANGED

**ROUND BARREL ALUMINUM (For 1" Material)**

PART #	DESCRIPTION	FINISH
7978	RH-IN or LH-OUT (8" Height)	Clear Anodized
7988	LH-IN or RH-OUT (8" Height)	Clear Anodized
8974	RH-IN or LH-OUT (8" Height)	Brite-Dip
8984	LH-IN or RH-OUT (8" Height)	Brite-Dip

Three Hinge Sets - One Top and Two Bottoms

73714	RH-IN or LH-OUT	of (8974)
73724	LH-IN or RH-OUT	of (8984)

Replacement Parts

97415	Set of Inserts for 3/4" Door and Post	Nylon-Black
8465	Cam & Pintle Set for Top Hinges	Nylon-Black
8475	Cam & Pin Set for Bottom Hinges	Nylon-Black

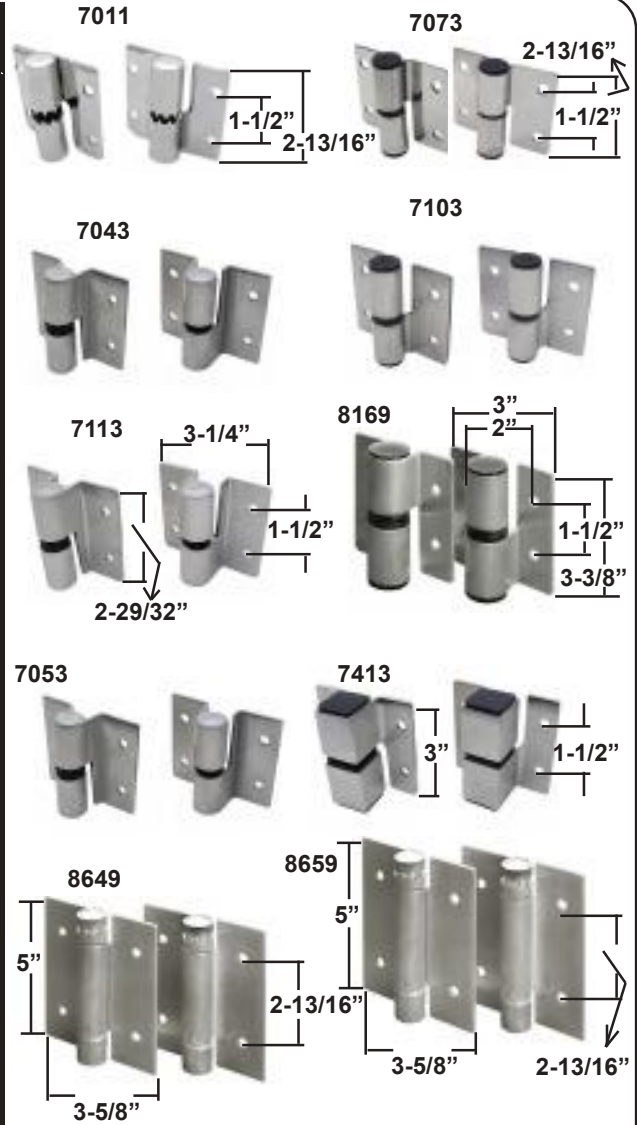

**PIANO HINGES**

MATERIAL THICKNESS	LENGTHS	DESCRIPTION	STAMPED STAINLESS STEEL
16 Gauge	54"	RH-IN or LH-OUT - Spring Close (1/8" Pin)	7959
	54"	LH-IN or RH-OUT - Spring Close (1/8" Pin)	7969
14 Gauge	57"	RH-IN or LH-OUT - Spring Close (1/4" Pin)	7339
	57"	LH-IN or RH-OUT - Spring Close (1/4" Pin)	7349
16 Gauge	57-1/2"	No Spring (1/8" Pin)	7649
	57-1/2"	RH-IN or LH-OUT - Spring Close (1/8" Pin)	7659
	57-1/2"	LH-IN or RH-OUT - Spring Close (1/8" Pin)	7669
	71-1/2"	RH-IN or LH-OUT - Spring Close (1/8" Pin)	7759
	71-1/2"	LH-IN or RH-OUT - Spring Close (1/8" Pin)	7769
14 Gauge	54-1/2"	RH-IN/OUT or LH-IN/OUT - Cam Close (1/4" Pin)	7599
	54-1/2"	RH-IN/OUT or LH-IN/OUT - Cam Close (1/4" Pin) (20° Open)	7609
	57-1/2"	RH-IN/OUT or LH-IN/OUT - Cam Close (1/4" Pin)	7789
	57-1/2"	RH-IN/OUT or LH-IN/OUT - Cam Close (1/4" Pin) (20° Open)	7799

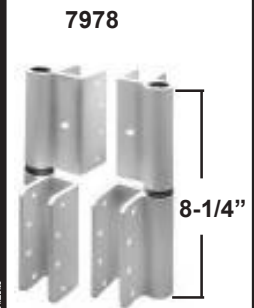

**Square Edge Posts**

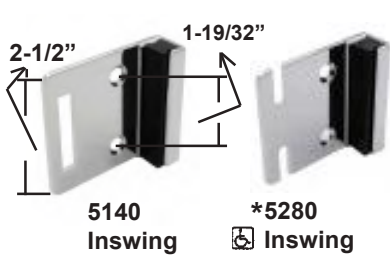

**5140**  
Inswing



**\*5280**  
Inswing



**\*5240**  
In or Out



**\*5260**  
Outswing



**\*5230**  
In or Out



**\*5110**  
Inswing



**\*5210**  
Outswing

**\*5340**  
Inswing

\* Overall height - 2-1/2"  
center to center hole  
spacing - 1-1/2"



**\*5160**  
Inswing

**\*111770**  
Inswing

**\*5180**  
Inswing

**\*5170**  
Inswing

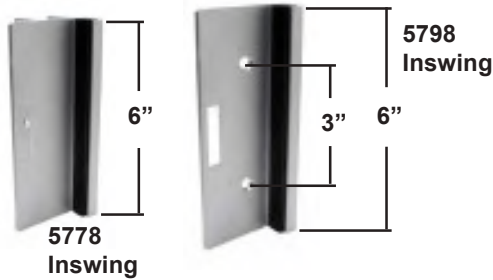

**5778**  
Inswing

**5798**  
Inswing

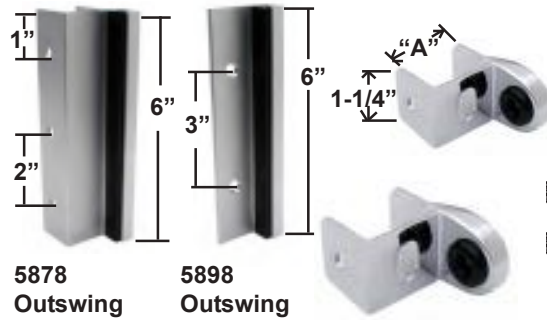

**5878**  
Outswing

**5898**  
Outswing

**5960**  
In or Out



**5980**  
Inswing

**5970**  
Outswing



**5650**  
Inswing

**5640**  
Outswing

"A" POST SIZE	DESCRIPTION	CHROME PLATED ZAMAC	"SATIN" FINISH ZAMAC	CHROME PLATED BRASS	POLISHED BRASS	CAST STAINLESS STEEL	ALUMINUM EXTRUSION (CLEAR ANODIZE)	ALUMINUM EXTRUSION (BRITE-DIP)
1"		5620				5623	5624	5628
1-1/8"	Inswing for Slide Latch	56104						
1-1/4"		5110	5118	5111	5112	5113		
3/4"						4913		
1"	Outswing for Slide Latch	5720				5723	5724	5728
1-1/8"		57104						
1-1/4"		5210	5218	5211	5212	5213		
1"	Inswing or Outswing for Concealed Latches	5730				5733		
1-1/4"		5230		5231	5232	5233		
1-1/4"	Inswing or Outswing for Concealed Latches	5220						
3/4"						4903		
1"	Inswing for Throw Latch (Emergency Access)	5820				5823	5824	
1-1/4"		5340		5341	5342	5343		
FLATS								
ALL	Inswing for Slide Latch	5140	5148	5141	5142	5143	5144	85148
ALL	Inswing or Outswing for Concealed Latches	5240		5241	5242	5243		
ALL	Outswing for Slide Latch	5260		5261	5262	5263	5264	85268
ALL	Inswing for Throw Latch (Emergency Access)	5280		5281	5282	5283		
HALVES & SETS								
ALL	Inswing Keeper for Slide Latch	5160		5161	5162	5163	5164	
ALL	Inswing or Outswing Strike for Slide Latches	5170		5171	5172	5173	5174	
ALL	Inswing Keeper for Throw Latch (Emergency Access)	5180		5181	5182	5183	5184	
ALL	Inswing Keeper for Throw Latch (Emergency Access) - Short Slot	111770						
ALL	Strike & Keeper 2 pc Pack (5160 & 5170)	5680				5683		
6" HIGH ALUMINUM								
1"	Inswing						5778	
1"	Outswing						5878	
ALL	Inswing (Flat)						5798	
ALL	Outswing (Flat)						5898	
HALF HEIGHT								
1-1/4"	Inswing or Outswing for Concealed Latches	5960				5963		
1-1/4"	Outswing for Slide Latch	5970				5973		
1-1/4"	Inswing for Throw Latch (Emergency Access)	5980				5983		
1-1/4"	Inswing or Outswing for Concealed Latches (1-1/4" Doors)	5840						
HALF HEIGHT-FLATS								
ALL	Inswing or Outswing for Concealed Latches	5630				5633		
ALL	Outswing for Slide Latch	5640				5643		
ALL	Inswing for Throw Latch (Emergency Access)	5650				5653		

**Round Edge Posts**

"A" POST SIZE	DESCRIPTION	CHROME PLATED ZAMAC	CHROME PLATED BRASS	CAST STAINLESS STEEL
1-1/4"	Inswing for Slide Latch	5310	5311	
1-1/4"	Inswing or Outswing for Concealed Latch with Flat Bar	5320	5321	
1-1/4"	Inswing for Throw Latch (Emergency Access)	5330		
1-1/4"	Outswing for Slide Latch	5410	5411	
1-1/4"	Inswing or Outswing for Concealed Latch with Round Bar	5430	5431	
1-1/4"	Inswing or Outswing for Concealed Latch	5550		
HALF HEIGHT				
1-1/4"	Inswing or Outswing for Concealed Latch	5470		
1-1/4"	Inswing or Outswing for Concealed Latch with Round Bar	5510	5511	5513
1-1/4"	Inswing or Outswing for Concealed Latch with Flat Bar	5520		
1-1/4"	Outswing for Slide Latch	5570		5573
1-1/4"	Inswing for Throw Latch (Emergency Access)	5580		5583
1-1/4"	Inswing or Outswing for Concealed Latch	5590		

5430  
In or Out



5320  
In or Out



5410  
Outswing



5330  
inswing



5310  
Inswing



5550  
In or Out



5510  
In or Out



5520  
In or Out



5470  
In or Out



5570  
Outswing



5580  
Inswing



**Stamped Stainless Steel Square Edge Posts\***

DOOR SIZE	DESCRIPTION	STAMPED STAINLESS STEEL
INSWING		
1/2"	Inswing Strike	6349
3/4"	Inswing Strike	6369
7/8"	Inswing Strike	6389
1"	Inswing Strike	6449
1-1/8"	Inswing Strike	6429
All	Keeper for Above Strikes	6499
All	Keeper for Above Strikes (Emergency Access)	6789
3/4"	Inswing Strike & Keeper - with Tab	6469
All	Inswing or Outswing Strike - One Piece	6329
All	Inswing Keeper - One Piece	6319
INSWING-FLATS		
3/4"	Inswing Strike & Keeper	5147509
7/8"	Inswing Strike & Keeper	5148759
1"	Inswing Strike & Keeper	5141009
1-1/4"	Inswing Strike & Keeper	5141259
3/4"	Inswing Strike & Keeper (Emergency Access)	5287509
7/8"	Inswing Strike & Keeper (Emergency Access)	5288759
1"	Inswing Strike & Keeper (Emergency Access)	5281009
1-1/4"	Inswing Strike & Keeper (Emergency Access)	5281259
OUTSWING		
1/2"	Outswing Strike & Keeper	6359
3/4"	Outswing Strike & Keeper	6379
7/8"	Outswing Strike & Keeper	6399
1"	Outswing Strike & Keeper	6459
1-1/8"	Outswing Strike & Keeper	6599
1/2"	Outswing Strike & Keeper (Emergency Access)	6899
3/4"	Outswing Strike & Keeper (Emergency Access)	6569
1"	Outswing Strike & Keeper (Emergency Access)	6559
OUTSWING-FLATS		
1/2"	Outswing Strike & Keeper	5265009
3/4"	Outswing Strike & Keeper	5267509
7/8"	Outswing Strike & Keeper	5268759
1/2"	Outswing Strike & Keeper (Emergency Access)	6435009
3/4"	Outswing Strike & Keeper (Emergency Access)	6437509
1"	Outswing Strike & Keeper (Emergency Access)	6431009



6789  
Inswing



6499  
Inswing



6389  
Inswing



5141009  
Inswing



5288759  
Inswing



6319  
Inswing



6329  
Inswing



6469  
Inswing

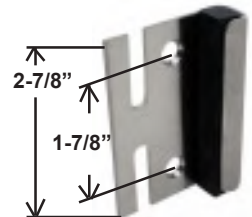

6437509  
Outswing



5268759  
Outswing



6569  
Outswing



6459  
Outswing





# Color Selection Guide for Powder Coated Steel Partitions

*Quick Ship*

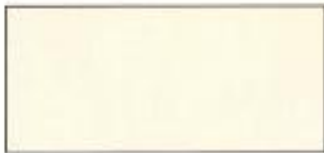

53 Ivory

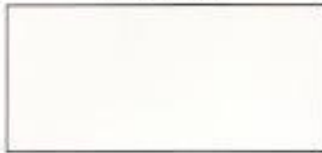

72 Almond

**Also Available in:  
Black  
White  
Stainless Steel**



22 Sky Blue



32 Tan

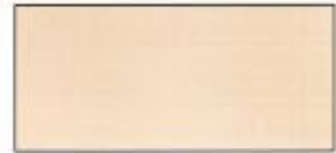

51 Sand

*Quick Ship*



43 Dark Green



30 Light Gray



90 Terra Cotta



50 Brown



21 Light Blue



31 Dark Gray



75 American Rose



70 Burgundy



78 Royal Blue

***NOTE: All colors and patterns are printed reproductions showing approximate color only. Blaine Window Hardware assumes no responsibility for absolute color fidelity.***



## Color Selection Guide for Plastic Laminate Partitions

*Quick Ship*



D154-60 Designer White



1572-60 Antique White

*Quick Ship*



D30-60 Natural Almond



1530-60 Beige



D97-60 Haze



D50-60 Khaki Brown



1500-60 Grey



D381-60 Fashion Grey

*Quick Ship*



D92-60 Dove Grey



D73-60 Pewter



D90-60 North Sea



1395-60 Black



D391-60 Cloud



D128-60 Larkspur



D25-60 Atlantis



D107-60 Hollyberry



D14-60 Port



D79-60 Hunter Green



4608-60 Caldera Beige



4669-60 Natural Tigris



4674-60 Evening Tigris



4657-60 Green Legacy



4662-60 Heather Legacy



4651-60 Nacy Legacy



4143-60 Neutral Glace



4142-60 Grey Glace



4621-60 White Nebula



4624-60 Beige Nebula



4627-60 Hunter Nebula



4623-60 Graphite Nebula

***NOTE: All colors and patterns are printed reproductions showing approximate color only. Blaine Window Hardware assumes no responsibility for absolute color fidelity.***



## Color Selection Guide for Solid Plastic Partitions

### CLASSICS



Burgundy



Hunter Green



Mocha



Black



Fossil



Parchment



White



Beige



Charcoal Grey



Grey



Linen



Blueberry

### IMPRESSIONS



Pavley



Beige Flint



Grey Slate



Cappoccino



Sandstone



Azure



Sand Castle



Glacier Grey

### EVERTUFF EX

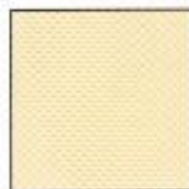

EX02 Beige



EX60 Metallic Grey



EX05 Black

***NOTE: All colors and patterns are printed reproductions showing approximate color only. Blaine Window Hardware assumes no responsibility for absolute color fidelity.***

**Square Edge Posts**

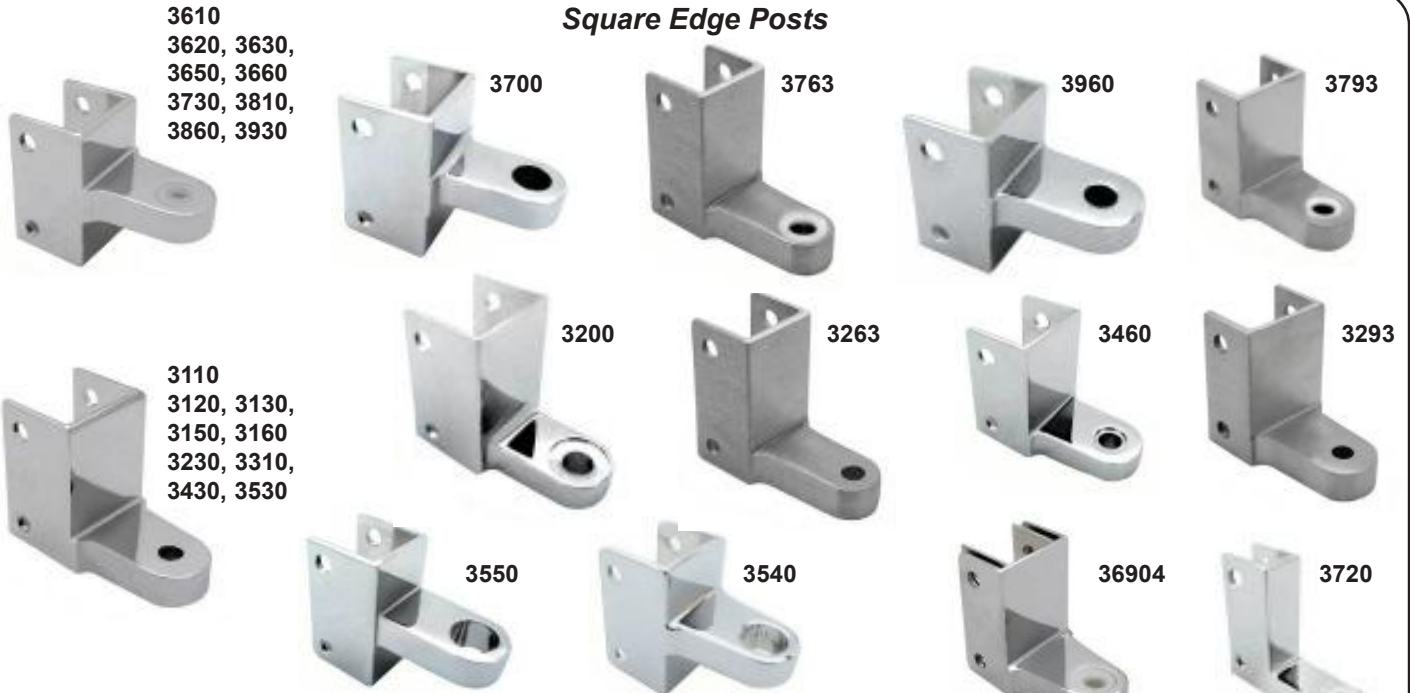

Post Size	Location	Chrome Plated Zamac	Chrome Plated Brass	Polished Brass	Cast S.S.	Description	Use Pin	Use Pintle or Candle	Use Cam	"A" Dim																																																																																																																																																																																																																																																			
1/2"	Top	3720				G-1/2	99585	98265	98275	1.265"																																																																																																																																																																																																																																																			
	Bottom	3220									1"	Top	3760			3763	G-4	99109	98265	98275	1.265"	Bottom	3260			3263	1-1/8"	Top	36904				G-2 (With Inserts)	99109	98175	98245	1.265"	Bottom	31904				1-1/4"	Top	3610	3611	3612	3613	AMPCO	99585	98265	98275	1.250"	Bottom	3110	3111	3112	3113	1-1/4"	Top	3620				GLOBAL		98175		1.155"	Bottom	3120				1.197"	1-1/4"	Top	3630	3631	3632	3633	FIAT	99574	98175	98185	1.275"	Bottom	3130	3131	3132	3133	1-1/4"	Top	3650	3651		3653	SHANAHAN	98544	98175	98195	1.363"	Bottom	3150	3151		3153	1-1/4"	Top	3660	3661	3662	3663	COLUMBIA	99109	98175	98245	1.265"	Bottom	3160	3161	3162	3163	1-1/4"	Top	3700			3703	ACCURATE				1.200"	Bottom	3200			3203	1-1/4"	Top	3730	3731		3733	FLUSH METAL	98584	98175	98185	1.200"	Bottom	3230	3231		3233	1-1/4"	Top	3790	3681	3682	3793	G-3	99109	98265	98275	1.265"	Bottom	3290	3181	3182	3293	98175	98245	1-1/4"	Top	3860			3863	KNICKERBOCKER (LAMINATE)	98614	97275		1.433"	Bottom	3530			3533	1-1/4"	Top	3810	3811		3813	KNICKERBOCKER & GENERAL (STEEL)	98614	97275	97265	1.385"	Bottom	3310	3311		3313	1-1/4"	Top	3930			3933	METPAR	98584	97235		1.104"	Bottom	3430			3433	1-1/4"	Top	3960				SANMETAL	98715	97280		1.093"	Bottom	3460				1"	Top & Bottom	3550				M-3 Bottom or Top	99109	89830	89820	1.300"	1-1/4"	Top & Bottom	3540	3541	3542
1"	Top	3760			3763	G-4	99109	98265	98275	1.265"																																																																																																																																																																																																																																																			
	Bottom	3260			3263						1-1/8"	Top	36904				G-2 (With Inserts)	99109	98175	98245	1.265"	Bottom	31904				1-1/4"	Top	3610	3611	3612	3613	AMPCO	99585	98265	98275	1.250"	Bottom	3110	3111	3112	3113	1-1/4"	Top	3620				GLOBAL		98175		1.155"	Bottom	3120				1.197"	1-1/4"	Top	3630	3631	3632	3633	FIAT	99574	98175	98185	1.275"	Bottom	3130	3131	3132	3133	1-1/4"	Top	3650	3651		3653	SHANAHAN	98544	98175	98195	1.363"	Bottom	3150	3151		3153	1-1/4"	Top	3660	3661	3662	3663	COLUMBIA	99109	98175	98245	1.265"	Bottom	3160	3161	3162	3163	1-1/4"	Top	3700			3703	ACCURATE				1.200"	Bottom	3200			3203	1-1/4"	Top	3730	3731		3733	FLUSH METAL	98584	98175	98185	1.200"	Bottom	3230	3231		3233	1-1/4"	Top	3790	3681	3682	3793	G-3	99109	98265	98275	1.265"	Bottom	3290	3181	3182	3293	98175	98245	1-1/4"	Top	3860			3863	KNICKERBOCKER (LAMINATE)	98614	97275		1.433"	Bottom	3530			3533	1-1/4"	Top	3810	3811		3813	KNICKERBOCKER & GENERAL (STEEL)	98614	97275	97265	1.385"	Bottom	3310	3311		3313	1-1/4"	Top	3930			3933	METPAR	98584	97235		1.104"	Bottom	3430			3433	1-1/4"	Top	3960				SANMETAL	98715	97280		1.093"	Bottom	3460				1"	Top & Bottom	3550				M-3 Bottom or Top	99109	89830	89820	1.300"	1-1/4"	Top & Bottom	3540	3541	3542		M - Bottom or Top	99109	89830	89820	1.300"										
1-1/8"	Top	36904				G-2 (With Inserts)	99109	98175	98245	1.265"																																																																																																																																																																																																																																																			
	Bottom	31904									1-1/4"	Top	3610	3611	3612	3613	AMPCO	99585	98265	98275	1.250"	Bottom	3110	3111	3112	3113	1-1/4"	Top	3620				GLOBAL		98175		1.155"	Bottom	3120				1.197"	1-1/4"	Top	3630	3631	3632	3633	FIAT	99574	98175	98185	1.275"	Bottom	3130	3131	3132	3133	1-1/4"	Top	3650	3651		3653	SHANAHAN	98544	98175	98195	1.363"	Bottom	3150	3151		3153	1-1/4"	Top	3660	3661	3662	3663	COLUMBIA	99109	98175	98245	1.265"	Bottom	3160	3161	3162	3163	1-1/4"	Top	3700			3703	ACCURATE				1.200"	Bottom	3200			3203	1-1/4"	Top	3730	3731		3733	FLUSH METAL	98584	98175	98185	1.200"	Bottom	3230	3231		3233	1-1/4"	Top	3790	3681	3682	3793	G-3	99109	98265	98275	1.265"	Bottom	3290	3181	3182	3293	98175	98245	1-1/4"	Top	3860			3863	KNICKERBOCKER (LAMINATE)	98614	97275		1.433"	Bottom	3530			3533	1-1/4"	Top	3810	3811		3813	KNICKERBOCKER & GENERAL (STEEL)	98614	97275	97265	1.385"	Bottom	3310	3311		3313	1-1/4"	Top	3930			3933	METPAR	98584	97235		1.104"	Bottom	3430			3433	1-1/4"	Top	3960				SANMETAL	98715	97280		1.093"	Bottom	3460				1"	Top & Bottom	3550				M-3 Bottom or Top	99109	89830	89820	1.300"	1-1/4"	Top & Bottom	3540	3541	3542		M - Bottom or Top	99109	89830	89820	1.300"																										
1-1/4"	Top	3610	3611	3612	3613	AMPCO	99585	98265	98275	1.250"																																																																																																																																																																																																																																																			
	Bottom	3110	3111	3112	3113						1-1/4"	Top	3620				GLOBAL		98175		1.155"	Bottom	3120				1.197"	1-1/4"	Top	3630	3631	3632	3633	FIAT	99574	98175	98185	1.275"	Bottom	3130	3131	3132	3133	1-1/4"	Top	3650	3651		3653	SHANAHAN	98544	98175	98195	1.363"	Bottom	3150	3151		3153	1-1/4"	Top	3660	3661	3662	3663	COLUMBIA	99109	98175	98245	1.265"	Bottom	3160	3161	3162	3163	1-1/4"	Top	3700			3703	ACCURATE				1.200"	Bottom	3200			3203	1-1/4"	Top	3730	3731		3733	FLUSH METAL	98584	98175	98185	1.200"	Bottom	3230	3231		3233	1-1/4"	Top	3790	3681	3682	3793	G-3	99109	98265	98275	1.265"	Bottom	3290	3181	3182	3293	98175	98245	1-1/4"	Top	3860			3863	KNICKERBOCKER (LAMINATE)	98614	97275		1.433"	Bottom	3530			3533	1-1/4"	Top	3810	3811		3813	KNICKERBOCKER & GENERAL (STEEL)	98614	97275	97265	1.385"	Bottom	3310	3311		3313	1-1/4"	Top	3930			3933	METPAR	98584	97235		1.104"	Bottom	3430			3433	1-1/4"	Top	3960				SANMETAL	98715	97280		1.093"	Bottom	3460				1"	Top & Bottom	3550				M-3 Bottom or Top	99109	89830	89820	1.300"	1-1/4"	Top & Bottom	3540	3541	3542		M - Bottom or Top	99109	89830	89820	1.300"																																										
1-1/4"	Top	3620				GLOBAL		98175		1.155"																																																																																																																																																																																																																																																			
	Bottom	3120								1.197"																																																																																																																																																																																																																																																			
1-1/4"	Top	3630	3631	3632	3633	FIAT	99574	98175	98185	1.275"																																																																																																																																																																																																																																																			
	Bottom	3130	3131	3132	3133						1-1/4"	Top	3650	3651		3653	SHANAHAN	98544	98175	98195	1.363"	Bottom	3150	3151		3153	1-1/4"	Top	3660	3661	3662	3663	COLUMBIA	99109	98175	98245	1.265"	Bottom	3160	3161	3162	3163	1-1/4"	Top	3700			3703	ACCURATE				1.200"	Bottom	3200			3203	1-1/4"	Top	3730	3731		3733	FLUSH METAL	98584	98175	98185	1.200"	Bottom	3230	3231		3233	1-1/4"	Top	3790	3681	3682	3793	G-3	99109	98265	98275	1.265"	Bottom	3290	3181	3182	3293	98175	98245	1-1/4"	Top	3860			3863	KNICKERBOCKER (LAMINATE)	98614	97275		1.433"	Bottom	3530			3533	1-1/4"	Top	3810	3811		3813	KNICKERBOCKER & GENERAL (STEEL)	98614	97275	97265	1.385"	Bottom	3310	3311		3313	1-1/4"	Top	3930			3933	METPAR	98584	97235		1.104"	Bottom	3430			3433	1-1/4"	Top	3960				SANMETAL	98715	97280		1.093"	Bottom	3460				1"	Top & Bottom	3550				M-3 Bottom or Top	99109	89830	89820	1.300"	1-1/4"	Top & Bottom	3540	3541	3542		M - Bottom or Top	99109	89830	89820	1.300"																																																																											
1-1/4"	Top	3650	3651		3653	SHANAHAN	98544	98175	98195	1.363"																																																																																																																																																																																																																																																			
	Bottom	3150	3151		3153						1-1/4"	Top	3660	3661	3662	3663	COLUMBIA	99109	98175	98245	1.265"	Bottom	3160	3161	3162	3163	1-1/4"	Top	3700			3703	ACCURATE				1.200"	Bottom	3200			3203	1-1/4"	Top	3730	3731		3733	FLUSH METAL	98584	98175	98185	1.200"	Bottom	3230	3231		3233	1-1/4"	Top	3790	3681	3682	3793	G-3	99109	98265	98275	1.265"	Bottom	3290	3181	3182	3293	98175	98245	1-1/4"	Top	3860			3863	KNICKERBOCKER (LAMINATE)	98614	97275		1.433"	Bottom	3530			3533	1-1/4"	Top	3810	3811		3813	KNICKERBOCKER & GENERAL (STEEL)	98614	97275	97265	1.385"	Bottom	3310	3311		3313	1-1/4"	Top	3930			3933	METPAR	98584	97235		1.104"	Bottom	3430			3433	1-1/4"	Top	3960				SANMETAL	98715	97280		1.093"	Bottom	3460				1"	Top & Bottom	3550				M-3 Bottom or Top	99109	89830	89820	1.300"	1-1/4"	Top & Bottom	3540	3541	3542		M - Bottom or Top	99109	89830	89820	1.300"																																																																																											
1-1/4"	Top	3660	3661	3662	3663	COLUMBIA	99109	98175	98245	1.265"																																																																																																																																																																																																																																																			
	Bottom	3160	3161	3162	3163						1-1/4"	Top	3700			3703	ACCURATE				1.200"	Bottom	3200			3203	1-1/4"	Top	3730	3731		3733	FLUSH METAL	98584	98175	98185	1.200"	Bottom	3230	3231		3233	1-1/4"	Top	3790	3681	3682	3793	G-3	99109	98265	98275	1.265"	Bottom	3290	3181	3182	3293	98175	98245	1-1/4"	Top	3860			3863	KNICKERBOCKER (LAMINATE)	98614	97275		1.433"	Bottom	3530			3533	1-1/4"	Top	3810	3811		3813	KNICKERBOCKER & GENERAL (STEEL)	98614	97275	97265	1.385"	Bottom	3310	3311		3313	1-1/4"	Top	3930			3933	METPAR	98584	97235		1.104"	Bottom	3430			3433	1-1/4"	Top	3960				SANMETAL	98715	97280		1.093"	Bottom	3460				1"	Top & Bottom	3550				M-3 Bottom or Top	99109	89830	89820	1.300"	1-1/4"	Top & Bottom	3540	3541	3542		M - Bottom or Top	99109	89830	89820	1.300"																																																																																																											
1-1/4"	Top	3700			3703	ACCURATE				1.200"																																																																																																																																																																																																																																																			
	Bottom	3200			3203						1-1/4"	Top	3730	3731		3733	FLUSH METAL	98584	98175	98185	1.200"	Bottom	3230	3231		3233	1-1/4"	Top	3790	3681	3682	3793	G-3	99109	98265	98275	1.265"	Bottom	3290	3181	3182	3293	98175	98245	1-1/4"	Top	3860			3863	KNICKERBOCKER (LAMINATE)	98614	97275		1.433"	Bottom	3530			3533	1-1/4"	Top	3810	3811		3813	KNICKERBOCKER & GENERAL (STEEL)	98614	97275	97265	1.385"	Bottom	3310	3311		3313	1-1/4"	Top	3930			3933	METPAR	98584	97235		1.104"	Bottom	3430			3433	1-1/4"	Top	3960				SANMETAL	98715	97280		1.093"	Bottom	3460				1"	Top & Bottom	3550				M-3 Bottom or Top	99109	89830	89820	1.300"	1-1/4"	Top & Bottom	3540	3541	3542		M - Bottom or Top	99109	89830	89820	1.300"																																																																																																																											
1-1/4"	Top	3730	3731		3733	FLUSH METAL	98584	98175	98185	1.200"																																																																																																																																																																																																																																																			
	Bottom	3230	3231		3233						1-1/4"	Top	3790	3681	3682	3793	G-3	99109	98265	98275	1.265"	Bottom	3290	3181	3182	3293	98175	98245	1-1/4"	Top	3860			3863	KNICKERBOCKER (LAMINATE)	98614	97275		1.433"	Bottom	3530			3533	1-1/4"	Top	3810	3811		3813	KNICKERBOCKER & GENERAL (STEEL)	98614	97275	97265	1.385"	Bottom	3310	3311		3313	1-1/4"	Top	3930			3933	METPAR	98584	97235		1.104"	Bottom	3430			3433	1-1/4"	Top	3960				SANMETAL	98715	97280		1.093"	Bottom	3460				1"	Top & Bottom	3550				M-3 Bottom or Top	99109	89830	89820	1.300"	1-1/4"	Top & Bottom	3540	3541	3542		M - Bottom or Top	99109	89830	89820	1.300"																																																																																																																																											
1-1/4"	Top	3790	3681	3682	3793	G-3	99109	98265	98275	1.265"																																																																																																																																																																																																																																																			
	Bottom	3290	3181	3182	3293			98175	98245																																																																																																																																																																																																																																																				
1-1/4"	Top	3860			3863	KNICKERBOCKER (LAMINATE)	98614	97275		1.433"																																																																																																																																																																																																																																																			
	Bottom	3530			3533						1-1/4"	Top	3810	3811		3813	KNICKERBOCKER & GENERAL (STEEL)	98614	97275	97265	1.385"	Bottom	3310	3311		3313	1-1/4"	Top	3930			3933	METPAR	98584	97235		1.104"	Bottom	3430			3433	1-1/4"	Top	3960				SANMETAL	98715	97280		1.093"	Bottom	3460				1"	Top & Bottom	3550				M-3 Bottom or Top	99109	89830	89820	1.300"	1-1/4"	Top & Bottom	3540	3541	3542		M - Bottom or Top	99109	89830	89820	1.300"																																																																																																																																																																													
1-1/4"	Top	3810	3811		3813	KNICKERBOCKER & GENERAL (STEEL)	98614	97275	97265	1.385"																																																																																																																																																																																																																																																			
	Bottom	3310	3311		3313						1-1/4"	Top	3930			3933	METPAR	98584	97235		1.104"	Bottom	3430			3433	1-1/4"	Top	3960				SANMETAL	98715	97280		1.093"	Bottom	3460				1"	Top & Bottom	3550				M-3 Bottom or Top	99109	89830	89820	1.300"	1-1/4"	Top & Bottom	3540	3541	3542		M - Bottom or Top	99109	89830	89820	1.300"																																																																																																																																																																																													
1-1/4"	Top	3930			3933	METPAR	98584	97235		1.104"																																																																																																																																																																																																																																																			
	Bottom	3430			3433						1-1/4"	Top	3960				SANMETAL	98715	97280		1.093"	Bottom	3460				1"	Top & Bottom	3550				M-3 Bottom or Top	99109	89830	89820	1.300"	1-1/4"	Top & Bottom	3540	3541	3542		M - Bottom or Top	99109	89830	89820	1.300"																																																																																																																																																																																																													
1-1/4"	Top	3960				SANMETAL	98715	97280		1.093"																																																																																																																																																																																																																																																			
	Bottom	3460									1"	Top & Bottom	3550				M-3 Bottom or Top	99109	89830	89820	1.300"	1-1/4"	Top & Bottom	3540	3541	3542		M - Bottom or Top	99109	89830	89820	1.300"																																																																																																																																																																																																																													
1"	Top & Bottom	3550				M-3 Bottom or Top	99109	89830	89820	1.300"																																																																																																																																																																																																																																																			
1-1/4"	Top & Bottom	3540	3541	3542		M - Bottom or Top	99109	89830	89820	1.300"																																																																																																																																																																																																																																																			

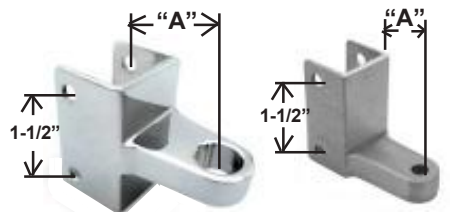

Post	Door	Pivot Hinge (Roller Bearing Design)			
1/2"	1/2"				7803
3/4" & 1"	1/2"				7853 Includes 3/4" Inserts
3/4" & 1"	3/4" & 1"				7813 Includes 3/4" Inserts



**Round Edge Posts**



3510



3010



3900



4533



3910



3060



4043



3420

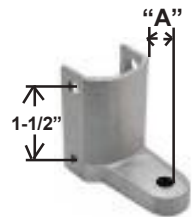

Post Size	Location	Chrome Plated Zamac	Chrome Plated Brass	Polished Brass	Cast S.S.	Description	Use Pin	Use Pintle or Candle	Use Cam	"A" Dim
1-1/4"	Top	3510	3511	3512	3513	FLUSH METAL	98584	98175	98185	1.085"
	Bottom	3010	3011	3012	3013					1.156"
1-1/4"	Top	3900			3903	SANY METAL	98715	97290		1.065"
	Bottom	3060			3403					
1-1/4"	Top	3910			3913	KNICKERBOCKER & GENERAL	98614	97265		1.385"
	Bottom	3420			3423					97275
1-1/4"	Top	4530	4531		4533	METPAR	98584		97235	1.070"
	Bottom	4040	4041		4043					1.104"
1-1/4"	Top	4530	4531		4533	AMPCO	98584	98175	98185	1.070"
	Bottom	4040	4041		4043					1.104"



3710



3753



3210



3253



3740  
3880, 3940,  
3970



3240  
3280, 3470,  
3870

**Flats**

Location	Chrome Plated Zamac	Chrome Plated Brass	Polished Brass	Cast S.S.	Description	Use Pin	Use Pintle or Candle		"A" Dim
Top	3710			3713	ACCURATE				1.200"
Bottom	3210			3213					
Top	3740	3741		3743	AMPCO (LAMINATE)	99585	98265	98275	1.250"
Bottom	3240	3241		3243					
Top	3880		3883		AMPCO & METPAR (STEEL)	98584	97245	98185	1.104"
Bottom	3280		3283						
Top	3750	3751	3752	3753	G-3	99109	98265	98275	1.265"
Bottom	3250	3251	3252	3253					
Top	3940			3943	KNICKERBOCKER (LAMINATE)	98614	97275		1.433"
Bottom	3870			3873					
Top	3970	3971		3973	KNICKERBOCKER & GENERAL (STEEL)	98614	97275	97265	1.385"
Bottom	3470	3471		3473					

**Square Edge Posts**

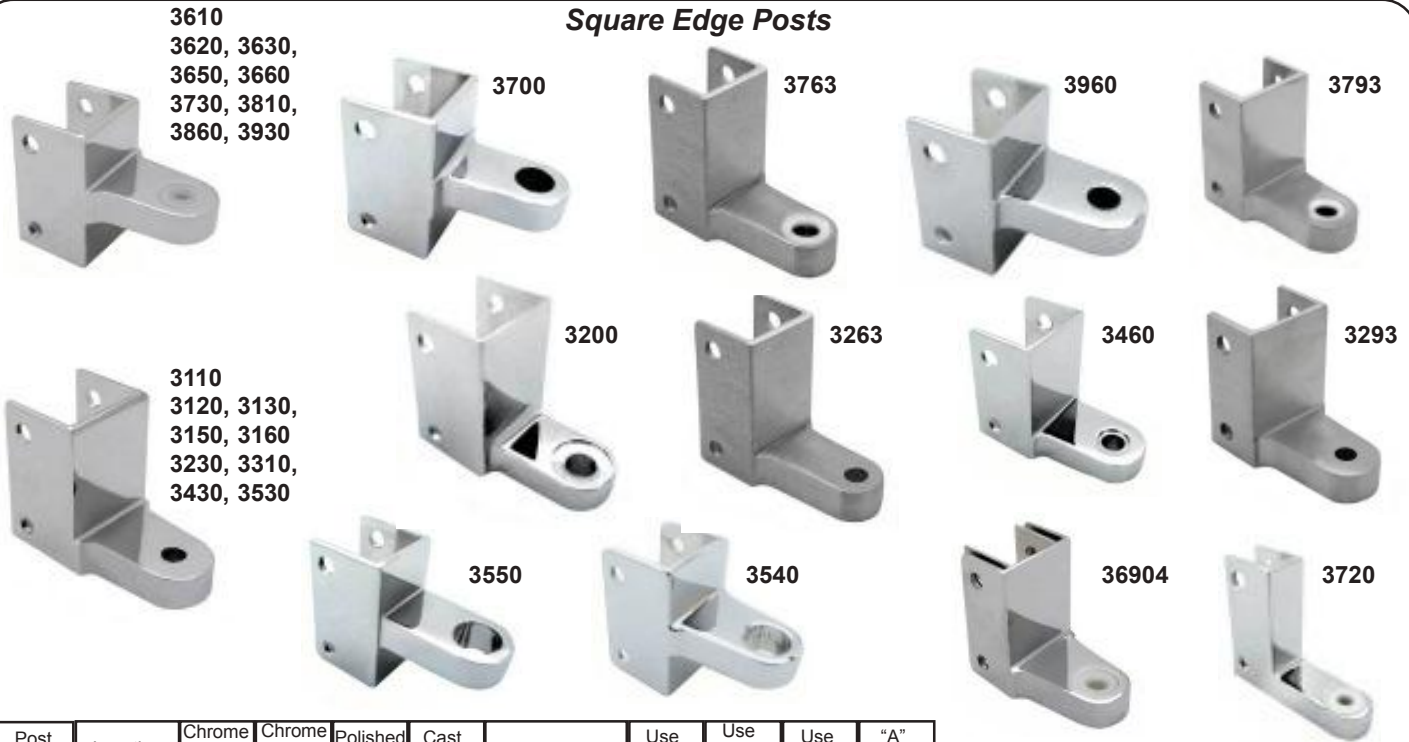

Post Size	Location	Chrome Plated Zamac	Chrome Plated Brass	Polished Brass	Cast S.S.	Description	Use Pin	Use Pintle or Candle	Use Cam	"A" Dim																																																																																																																																																																																																																																																	
1/2"	Top	3720				G-1/2	99585	98265	98275	1.265"																																																																																																																																																																																																																																																	
	Bottom	3220									1"	Top	3760			3763	G-4	99109	98265	98275	1.265"	Bottom	3260			3263	1-1/8"	Top	36904				G-2 (With Inserts)	99109	98175	98245	1.265"	Bottom	31904				1-1/4"	Top	3610	3611	3612	3613	AMPCO	99585	98265	98275	1.250"	Bottom	3110	3111	3112	3113	1-1/4"	Top	3620				GLOBAL		98175		1.155"	Bottom	3120				1.197"	1-1/4"	Top	3630	3631	3632	3633	FAT	99574	98175	98185	1.275"	Bottom	3130	3131	3132	3133	1-1/4"	Top	3650	3651		3653	SHANAHAN	98544	98175	98195	1.363"	Bottom	3150	3151		3153	1-1/4"	Top	3660	3661	3662	3663	COLUMBIA	99109	98175	98245	1.265"	Bottom	3160	3161	3162	3163	1-1/4"	Top	3700			3703	ACCURATE				1.200"	Bottom	3200			3203	1-1/4"	Top	3730	3731		3733	FLUSH METAL	98584	98175	98185	1.200"	Bottom	3230	3231		3233	1-1/4"	Top	3790	3681	3682	3793	G-3	99109	98265	98275	1.265"	Bottom	3290	3181	3182	3293	1-1/4"	Top	3860			3863	KNICKERBOCKER (LAMINATE)	98614	97275		1.433"	Bottom	3530			3533	1-1/4"	Top	3810	3811		3813	KNICKERBOCKER & GENERAL (STEEL)	98614	97275	97265	1.385"	Bottom	3310	3311		3313	1-1/4"	Top	3930			3933	METPAR	98584	97235		1.104"	Bottom	3430			3433	1-1/4"	Top	3960				SANYMETAL	98715	97280		1.093"	Bottom	3460				1"	Top & Bottom	3550				M-3 Bottom or Top	99109	89830	89820	1.300"	1-1/4"	Top & Bottom	3540	3541	3542
1"	Top	3760			3763	G-4	99109	98265	98275	1.265"																																																																																																																																																																																																																																																	
	Bottom	3260			3263						1-1/8"	Top	36904				G-2 (With Inserts)	99109	98175	98245	1.265"	Bottom	31904				1-1/4"	Top	3610	3611	3612	3613	AMPCO	99585	98265	98275	1.250"	Bottom	3110	3111	3112	3113	1-1/4"	Top	3620				GLOBAL		98175		1.155"	Bottom	3120				1.197"	1-1/4"	Top	3630	3631	3632	3633	FAT	99574	98175	98185	1.275"	Bottom	3130	3131	3132	3133	1-1/4"	Top	3650	3651		3653	SHANAHAN	98544	98175	98195	1.363"	Bottom	3150	3151		3153	1-1/4"	Top	3660	3661	3662	3663	COLUMBIA	99109	98175	98245	1.265"	Bottom	3160	3161	3162	3163	1-1/4"	Top	3700			3703	ACCURATE				1.200"	Bottom	3200			3203	1-1/4"	Top	3730	3731		3733	FLUSH METAL	98584	98175	98185	1.200"	Bottom	3230	3231		3233	1-1/4"	Top	3790	3681	3682	3793	G-3	99109	98265	98275	1.265"	Bottom	3290	3181	3182	3293	1-1/4"	Top	3860			3863	KNICKERBOCKER (LAMINATE)	98614	97275		1.433"	Bottom	3530			3533	1-1/4"	Top	3810	3811		3813	KNICKERBOCKER & GENERAL (STEEL)	98614	97275	97265	1.385"	Bottom	3310	3311		3313	1-1/4"	Top	3930			3933	METPAR	98584	97235		1.104"	Bottom	3430			3433	1-1/4"	Top	3960				SANYMETAL	98715	97280		1.093"	Bottom	3460				1"	Top & Bottom	3550				M-3 Bottom or Top	99109	89830	89820	1.300"	1-1/4"	Top & Bottom	3540	3541	3542		M - Bottom or Top	99109	89830	89820	1.300"										
1-1/8"	Top	36904				G-2 (With Inserts)	99109	98175	98245	1.265"																																																																																																																																																																																																																																																	
	Bottom	31904									1-1/4"	Top	3610	3611	3612	3613	AMPCO	99585	98265	98275	1.250"	Bottom	3110	3111	3112	3113	1-1/4"	Top	3620				GLOBAL		98175		1.155"	Bottom	3120				1.197"	1-1/4"	Top	3630	3631	3632	3633	FAT	99574	98175	98185	1.275"	Bottom	3130	3131	3132	3133	1-1/4"	Top	3650	3651		3653	SHANAHAN	98544	98175	98195	1.363"	Bottom	3150	3151		3153	1-1/4"	Top	3660	3661	3662	3663	COLUMBIA	99109	98175	98245	1.265"	Bottom	3160	3161	3162	3163	1-1/4"	Top	3700			3703	ACCURATE				1.200"	Bottom	3200			3203	1-1/4"	Top	3730	3731		3733	FLUSH METAL	98584	98175	98185	1.200"	Bottom	3230	3231		3233	1-1/4"	Top	3790	3681	3682	3793	G-3	99109	98265	98275	1.265"	Bottom	3290	3181	3182	3293	1-1/4"	Top	3860			3863	KNICKERBOCKER (LAMINATE)	98614	97275		1.433"	Bottom	3530			3533	1-1/4"	Top	3810	3811		3813	KNICKERBOCKER & GENERAL (STEEL)	98614	97275	97265	1.385"	Bottom	3310	3311		3313	1-1/4"	Top	3930			3933	METPAR	98584	97235		1.104"	Bottom	3430			3433	1-1/4"	Top	3960				SANYMETAL	98715	97280		1.093"	Bottom	3460				1"	Top & Bottom	3550				M-3 Bottom or Top	99109	89830	89820	1.300"	1-1/4"	Top & Bottom	3540	3541	3542		M - Bottom or Top	99109	89830	89820	1.300"																										
1-1/4"	Top	3610	3611	3612	3613	AMPCO	99585	98265	98275	1.250"																																																																																																																																																																																																																																																	
	Bottom	3110	3111	3112	3113						1-1/4"	Top	3620				GLOBAL		98175		1.155"	Bottom	3120				1.197"	1-1/4"	Top	3630	3631	3632	3633	FAT	99574	98175	98185	1.275"	Bottom	3130	3131	3132	3133	1-1/4"	Top	3650	3651		3653	SHANAHAN	98544	98175	98195	1.363"	Bottom	3150	3151		3153	1-1/4"	Top	3660	3661	3662	3663	COLUMBIA	99109	98175	98245	1.265"	Bottom	3160	3161	3162	3163	1-1/4"	Top	3700			3703	ACCURATE				1.200"	Bottom	3200			3203	1-1/4"	Top	3730	3731		3733	FLUSH METAL	98584	98175	98185	1.200"	Bottom	3230	3231		3233	1-1/4"	Top	3790	3681	3682	3793	G-3	99109	98265	98275	1.265"	Bottom	3290	3181	3182	3293	1-1/4"	Top	3860			3863	KNICKERBOCKER (LAMINATE)	98614	97275		1.433"	Bottom	3530			3533	1-1/4"	Top	3810	3811		3813	KNICKERBOCKER & GENERAL (STEEL)	98614	97275	97265	1.385"	Bottom	3310	3311		3313	1-1/4"	Top	3930			3933	METPAR	98584	97235		1.104"	Bottom	3430			3433	1-1/4"	Top	3960				SANYMETAL	98715	97280		1.093"	Bottom	3460				1"	Top & Bottom	3550				M-3 Bottom or Top	99109	89830	89820	1.300"	1-1/4"	Top & Bottom	3540	3541	3542		M - Bottom or Top	99109	89830	89820	1.300"																																										
1-1/4"	Top	3620				GLOBAL		98175		1.155"																																																																																																																																																																																																																																																	
	Bottom	3120								1.197"																																																																																																																																																																																																																																																	
1-1/4"	Top	3630	3631	3632	3633	FAT	99574	98175	98185	1.275"																																																																																																																																																																																																																																																	
	Bottom	3130	3131	3132	3133																																																																																																																																																																																																																																																						
1-1/4"	Top	3650	3651		3653	SHANAHAN	98544	98175	98195	1.363"																																																																																																																																																																																																																																																	
	Bottom	3150	3151		3153																																																																																																																																																																																																																																																						
1-1/4"	Top	3660	3661	3662	3663	COLUMBIA	99109	98175	98245	1.265"																																																																																																																																																																																																																																																	
	Bottom	3160	3161	3162	3163																																																																																																																																																																																																																																																						
1-1/4"	Top	3700			3703	ACCURATE				1.200"																																																																																																																																																																																																																																																	
	Bottom	3200			3203																																																																																																																																																																																																																																																						
1-1/4"	Top	3730	3731		3733	FLUSH METAL	98584	98175	98185	1.200"																																																																																																																																																																																																																																																	
	Bottom	3230	3231		3233																																																																																																																																																																																																																																																						
1-1/4"	Top	3790	3681	3682	3793	G-3	99109	98265	98275	1.265"																																																																																																																																																																																																																																																	
	Bottom	3290	3181	3182	3293																																																																																																																																																																																																																																																						
1-1/4"	Top	3860			3863	KNICKERBOCKER (LAMINATE)	98614	97275		1.433"																																																																																																																																																																																																																																																	
	Bottom	3530			3533																																																																																																																																																																																																																																																						
1-1/4"	Top	3810	3811		3813	KNICKERBOCKER & GENERAL (STEEL)	98614	97275	97265	1.385"																																																																																																																																																																																																																																																	
	Bottom	3310	3311		3313																																																																																																																																																																																																																																																						
1-1/4"	Top	3930			3933	METPAR	98584	97235		1.104"																																																																																																																																																																																																																																																	
	Bottom	3430			3433																																																																																																																																																																																																																																																						
1-1/4"	Top	3960				SANYMETAL	98715	97280		1.093"																																																																																																																																																																																																																																																	
	Bottom	3460																																																																																																																																																																																																																																																									
1"	Top & Bottom	3550				M-3 Bottom or Top	99109	89830	89820	1.300"																																																																																																																																																																																																																																																	
1-1/4"	Top & Bottom	3540	3541	3542		M - Bottom or Top	99109	89830	89820	1.300"																																																																																																																																																																																																																																																	

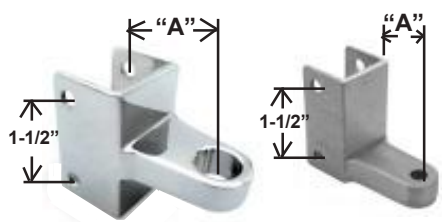

Post	Door	Pivot Hinge (Roller Bearing Design)				
1/2"	1/2"				7803	
3/4" & 1"	1/2"				7853	Includes 3/4" Inserts
3/4" & 1"	3/4" & 1"				7813	Includes 3/4" Inserts

**Round Edge Posts**

Post Size	Location	Chrome Plated Zamac	Chrome Plated Brass	Polished Brass	Cast S.S.	Description	Use Pin	Use Pintle or Candle	Use Cam	"A" Dim
1-1/4"	Top	3510	3511	3512	3513	FLUSH METAL	98584	98175	98185	1.085"
	Bottom	3010	3011	3012	3013					1.156"
1-1/4"	Top	3900			3903	SANY METAL	98715	97290		1.065"
	Bottom	3060			3403					
1-1/4"	Top	3910			3913	KNICKERBOCKER & GENERAL	98614	97265		1.385"
	Bottom	3420			3423			97275		
1-1/4"	Top	4530	4531		4533	METPAR	98584		97235	1.070"
	Bottom	4040	4041		4043			1.104"		
1-1/4"	Top	4530	4531		4533	AMPKO	98584	98175	98185	1.070"
	Bottom	4040	4041		4043					1.104"



3510



3010



3900



4533



3910



3060



4043



3420

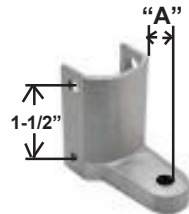

**Flats**

Location	Chrome Plated Zamac	Chrome Plated Brass	Polished Brass	Cast S.S.	Description	Use Pin	Use Pintle or Candle		"A" Dim
Top	3710			3713	ACCURATE				1.200"
Bottom	3210			3213					
Top	3740	3741		3743	AMPKO (LAMINATE)	99585	98265	98275	1.250"
Bottom	3240	3241		3243					
Top	3880		3883		AMPKO & METPAR (STEEL)	98584	97245	98185	1.104"
Bottom	3280		3283				98175		
Top	3750	3751	3752	3753	G-3	99109	98265	98275	1.265"
Bottom	3250	3251	3252	3253			98175	98245	
Top	3940			3943	KNICKERBOCKER (LAMINATE)	98614	97275		1.433"
Bottom	3870			3873					
Top	3970	3971		3973	KNICKERBOCKER & GENERAL (STEEL)	98614	97275	97265	1.385"
Bottom	3470	3471		3473					



3710



3753

1-7/16"

2-1/4"



3210



3253

2-1/4"



3740  
3880, 3940,  
3970

2-1/4"



3240  
3280, 3470,  
3870

2-1/4"



**Concealed Latches & Knob Sets**

**For 1" Doors**

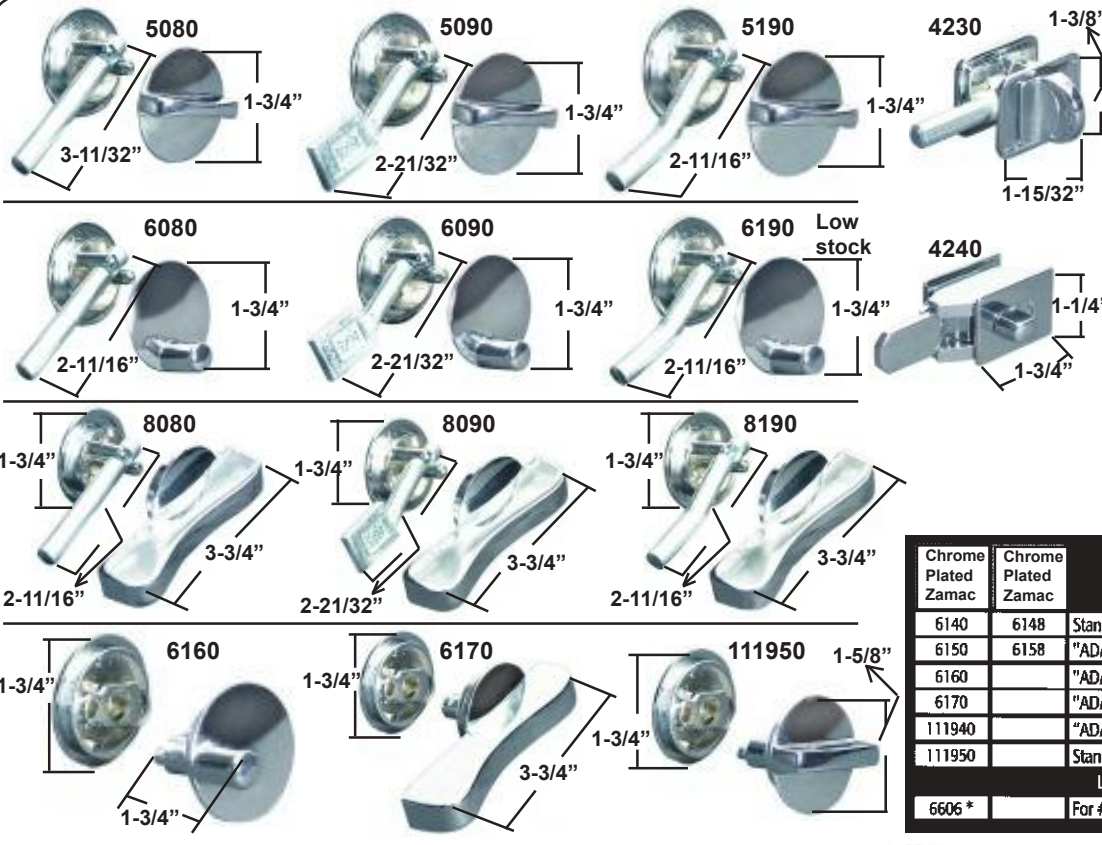

Chrome Plated Zamac	CONCEALED LATCHES
5080	Laminate Doors
5090	Steel Doors - Flat Tip Bar
5190	Steel Doors
"ADA" DOORS	
6080	Laminate Doors
6090	Steel Doors - Flat Tip Bar
6190	Steel Doors
8080	Laminate Doors
8090	Steel Doors - Flat Tip Bar
8190	Steel Doors
8860	Steel Doors
SQUARE OPENINGS	
4230	Steel Doors
4240	Steel Doors with Indicator

Chrome Plated Zamac	Chrome Plated Zamac	Knob Sets
6140	6148	Standard - For #6606 Housing
6150	6158	"ADA" - For #6606 Housing
6160		"ADA" - For Knickerbocker & General Housing
6170		"ADA" - For Knickerbocker & General Housing
111940		"ADA" - For Sarymetal Housing
111950		Standard - For Knickerbocker & General Housing
LATCH HOUSING		
6606 *		For #6140 & 6150 Knob Sets *Non-Plated

**Door Pulls & Fix-It Kits**



Chrome Plated Zamac	Chrome Plated Brass	Polished Brass	Cast Stainless Steel	Stamped Stainless Steel	Door Pulls
5400	5401	5402	5403		3-1/2" Centers
	5421	5422	5423		4" Centers
5440			5443		3-1/2" Centers (Used with #5400)
54400			54403		Door Pull Set (#5400 & 5440 with mounting hardware)
6200	6201	6202	6203		2-3/4" Centers
	6251		6253		3" High "ADA"
				6419	5" Centers
6020					2-5/8" Centers



Chrome Plated Zamac	Cast Stainless Steel	Fix-It Kits (with stainless plate) (see inside back cover)
SQUARE EDGE DOORS		
115490		Fix-It Kit for Inswing Doors - 1"
115500		Fix-It Kit for Outswing Doors - 1"
115510		Fix-It Kit for Outswing Doors - 1" (with Door Pull)
RADIAL EDGE DOORS		
111680		Fix-It Kit for Inswing Doors - 1"
111690		Fix-It Kit for Outswing Doors - 1"
111700		Fix-It Kit for Outswing Doors - 1" (with Door Pull)
DOOR HOOK		
	115523	Fix-It Kit (Uses #4113 Hook)





All shoes are made of 22 gauge #304 stainless steel with #4 satin finish



**\*3" HIGH PILASTER SHOES**

**\*4" HIGH PILASTER SHOES**

Length	Width					
	1/2"	3/4"	7/8"	1"	1-1/8"	1-1/4"
2"	36029	35029	31029	34029	33029	32029
3"	36039	35039	31039	34039	33039	32039
4"	36049	35049	31049	34049	33049	32049
5"	36059	35059	31059	34059	33059	32059
6"	36069	35069	31069	34069	33069	32069
7"	36079	35079	31079	34079	33079	32079
8"	36089	35089	31089	34089	33089	32089
9"	36099	35099	31099	34099	33099	32099
10"	36109	35109	31109	34109	33109	32109
11"	36119	35119	31119	34119	33119	32119
12"	36129	35129	31129	34129	33129	32129
13"	36139	35139	31139	34139	33139	32139
14"	36149	35149	31149	34149	33149	32149
15"		35159	31159	34159	33159	32159
16"	36169	35169	31169	34169	33169	32169
17"		35179	31179	34179	33179	32179
18"	36189	35189	31189	34189	33189	32189
19"	36199	35199		34199	33199	32199
20"	36209	35209	31209	34209	33209	32209
21"		35219	31219	34219		32219
22"	36229	35229	31229	34229	33229	32229
23"		35239	31239	34239		32239
24"	36249	35249	31249	34249	33249	32249
25"	36259	35259	31259	34259	33259	32259
26"	36269	35269		34269	33269	32269
28"	36289	35289	31289	34289	33289	32289
30"	36309	35309	31309	34309	33309	32309

Length	Width					
	1/2"	3/4"	7/8"	1"	1-1/8"	1-1/4"
2"	46029	45029	41029	44029	43029	42029
3"	46039	45039	41039	44039	43039	42039
4"	46049	45049	41049	44049	43049	42049
5"	46059	45059	41059	44059	43059	42059
6"	46069	45069	41069	44069	43069	42069
7"	46079	45079	41079	44079	43079	42079
8"	46089	45089	41089	44089	43089	42089
9"	46099	45099	41099	44099	43099	42099
10"	46109	45109	41109	44109	43109	42109
11"	46119	45119	41119	44119	43119	42119
12"	46129	45129	41129	44129	43129	42129
13"		45139	41139	44139	43139	42139
14"	46149	45149	41149	44149	43149	42149
15"		45159		44159	43159	42159
16"	46169	45169	41169	44169	43169	42169
17"			41179	44179		42179
18"	46189	45189	41189	44189	43189	42189
19"			41199	44199	43199	42199
20"	46209	45209	41209	44209	43209	42209
21"		45219	41219	44219	43219	42219
22"	46229	45229	41229	44229	43229	42229
23"			41239	44239		42239
24"	46249	45249	41249	44249	43249	42249
25"		45259	41259	44259	43259	42259
26"	46269	45269		44269	43269	42269
28"	46289	45289		44289	43289	42289
30"	46309	45309	41309	44309	43309	42309

**4" HIGH 'OFFSET' PILASTER SHOES**

Length	Width		
	1/2"	3/4"	1"
2"	56029	55029	54029
3"	56039	55039	54039
4"	56049	55049	54049
5"	56059	55059	54059
6"	56069	55069	54069
7"	56079	55079	54079
8"	56089	55089	54089
9"	56099	55099	54099
10"	56109	55109	54109
12"	56129	55129	54129
14"	56149	55149	54149
16"	56169	55169	54169
18"	56189	55189	54189
20"	56209	55209	54209
22"	56229	55229	54229
24"	56249	55249	54249

widths measured at top opening

\*Custom sizes available upon request.  
Open ended available in all sizes.



**ANCHOR SHOES**

Length	Width		Length	Width	
	1-1/4"	1"		1"	1"
2"	61029		3"	30039	48039
3"	61039	62039	4"	30049	48049
4"	61049	62049	5"	30059	48059
5"	61059	62059	6"	30069	48069
6"	61069	62069	7"	30079	48079
7"	61079	62079	8"	30089	48089
8"	61089	62089	9"	30099	48099
9"		62099	10"	30109	48109
10"	61109	62109	11"	30119	
12"	61129	62129	12"	30129	48129
14"		62149	14"	30149	48149
18"	61189	62189	16"	30169	
20"	61209		18"	30189	48189
21"		62219	20"	30209	
24"	61249	62249	22"	30229	
30"		62309	24"	30249	48249



PART #	DESCRIPTION
3030	1-1/4" Pilaster Shoe (Use with #98334 Tube)
3040	1-3/4" Pilaster Shoe (Use with #98434 Tube)
6000	1-1/4" x 3" Post Shoe
8503	1-1/4" Pilaster Anchor Bracket (11-1/2" - 14" Range)
85083	1-1/4" Pilaster Anchor Bracket (9-1/2" - 12" Range)
85093	1-1/4" Pilaster Anchor Bracket (7-1/2" - 10" Range)
8513	1-1/4" Pilaster Anchor Bracket - One Ear (11-1/2" - 14" Range)
85183	1-1/4" Pilaster Anchor Bracket - One Ear (9-1/2" - 12" Range)
85193	1-1/4" Pilaster Anchor Bracket - One Ear (7-1/2" - 10" Range)

8503  
85083  
85093

8513  
85183  
85193



## Pilaster Post Anchoring Packs & Devices

30414

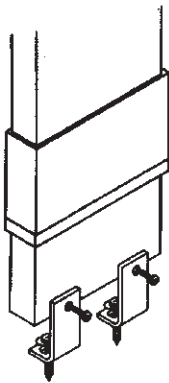

For 1" Thick and Larger Pilaster Posts.

30524, 30544,  
30584

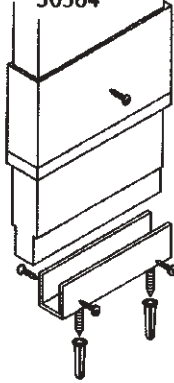

30524 For 1-1/4" X 2" to 4" Posts.  
30544 For 1-1/4" X 4" to 7" Posts.  
30584 For 1-1/4" X 8" & Up.

30619

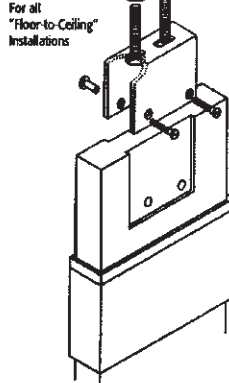

For all "Floor-to-Ceiling" Installations

For all size posts. Specify thickness of Pilaster Post when ordering.

30719

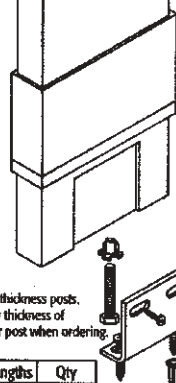

For all thickness posts. Specify thickness of pilaster post when ordering.

Post Lengths	Qty
3" - 5"	one pc
6" - 12"	two pcs
18" +	3 pcs

30810

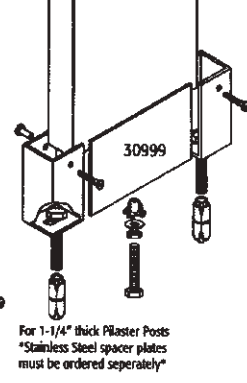

For 1-1/4" thick Pilaster Posts "Stainless Steel spacer plates must be ordered separately"

30999

Stainless Steel spacer plates measure 3"x10" Other lengths can be fabricated upon request.

31016

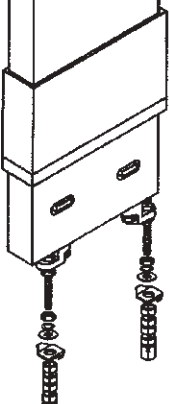

For 1-1/4" & 1-1/8" Posts.

31056

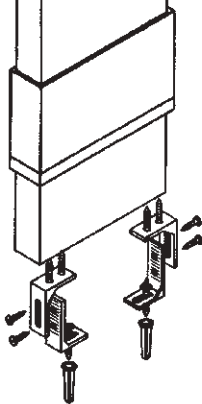

For 3/4" thick & larger Pilaster Posts.

74030

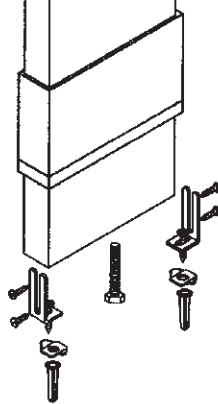

For 1-1/4" & 1-1/8" Posts.

83314

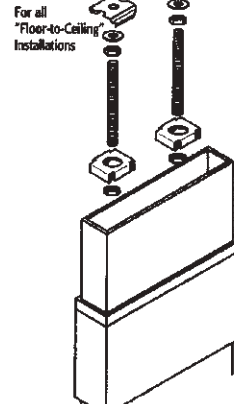

For all "Floor-to-Ceiling" Installations

For 1-1/4" steel Pilaster Posts.

83354

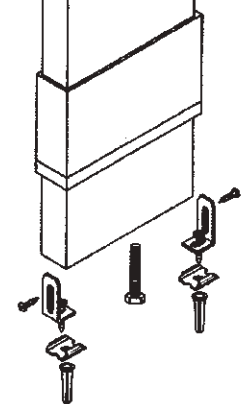

For 1-1/4" & 1-1/8" Posts.

3080

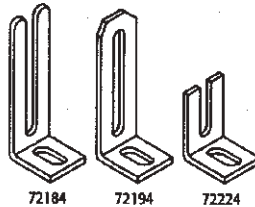
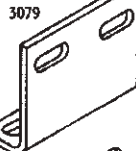
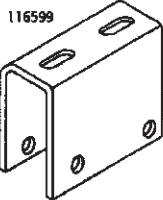
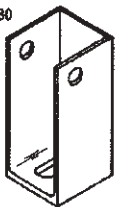

72184 72194 72224

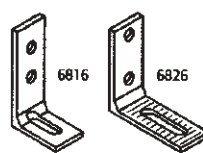

6816 6826

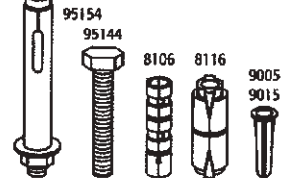

95154 95144 8106 8116 9005 9015



96356 72214 96924 96324 96914



87304-87934



3106 96374 72204 72274

PILASTER MOUNTING BARS	
Part #	Post Size
65039	3"
65049	4"
65059	5"
65069	6"
65079	7"
65089	8"
65099	9"
65109	10"
65129	12"

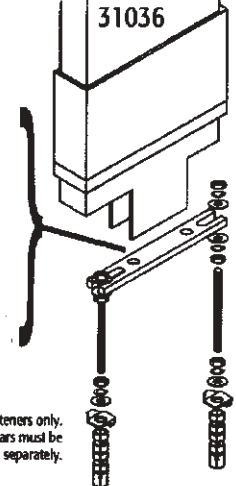

Consists of Fasteners only. Mounting Bars must be ordered separately.

PART #	DESCRIPTION
3079	3" x 2-1/2" L-Bracket
3080	1-1/4" Split Pilaster Shoe (One-Piece)
3106	Pilaster Foot
6816	Top L-Anchor for Plastic Laminate
6826	Bottom L-Anchor for Plastic Laminate
8106	3/8" Expansion Floor Anchor
8116	3/8" Double Expansion Floor Anchor
9005	Plastic Anchor for #10 - 12 Screws
9015	Plastic Anchor for #14 - 16 Screws
30999	3" x 10" Spacer Plate (Two-Pack) Used with #3080
72184	Pilaster Anchor Fork (Open)
72194	Pilaster Anchor Fork (Closed)
72204	Spring Clip
72214	Box Clamp Anchor

PART #	DESCRIPTION
72224	Pilaster Anchoring Fork - Half Height (Open)
72274	Spring Clip
87304	3/8-16 x 4" Threaded Rod - Zinc Plated
87334	3/8-16 x 6" Threaded Rod - Zinc Plated
87374	3/8-16 x 8" Threaded Rod - Zinc Plated
87394	3/8-16 x 10" Threaded Rod - Zinc Plated
95144	3/8-16 x 2-1/2" Hex Bolt - Zinc Plated
95154	1/2" x 3" Anchor Sleeve with 3/8 Nut & Washer
96324	3/8-16 Hex Nut
96356	3/8-16 x 7/8" Square Nut
96374	3/8-16 4-Prong T-Nut
96914	3/8" Split Lock Washer
96924	3/8" Flat Washer
116599	3/4" X-Long U-Bracket

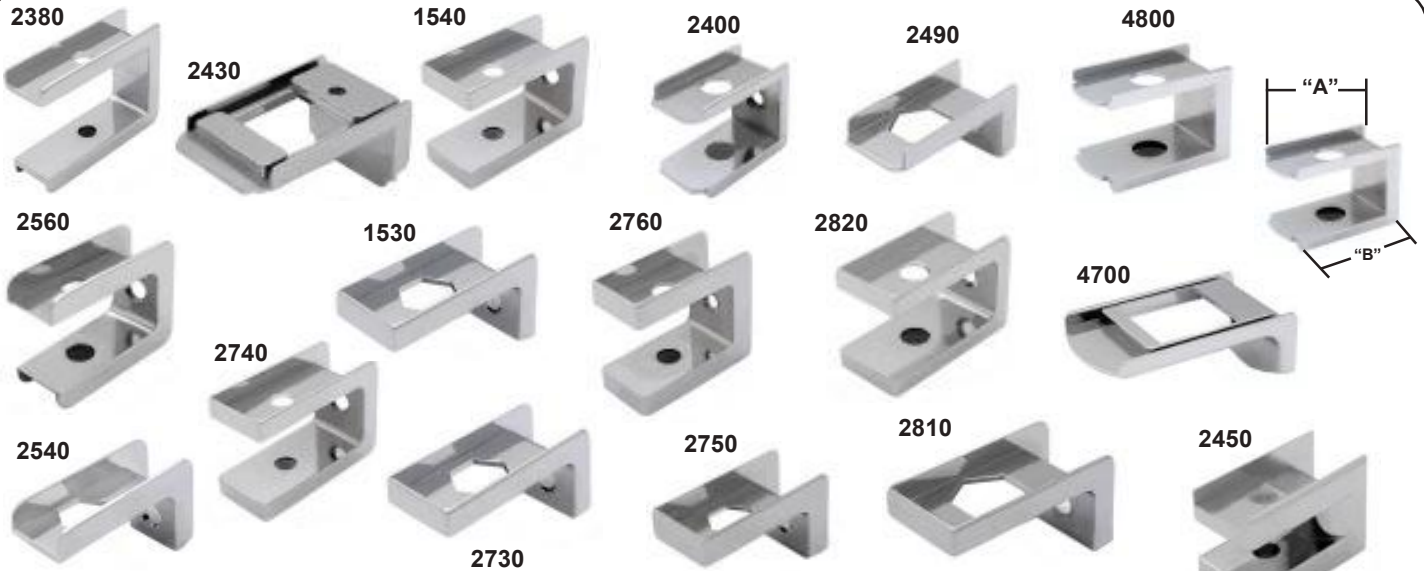

**FOR SQUARE EDGE DOORS**

Post Size	Location	Chrome Plated Zamac	Brass Plated Zamac	Satin Finish Zamac	Description	Use Pin	Use Pintle or Candle	Use Cam	"A" Dim	"B" Dim
1/2"	Top	2380				99585	Candle 98265	98275	2-1/16"	1-1/2"
	Bottom	2390							2"	
3/4"	Top	2560		2568		99109	98265	98275	2-11/32"	1-3/4"
	Bottom	2540		2548					2-11/32"	1-3/8"
7/8"	Top	1540	1542	1548		99109	98265	98275	2-3/8"	1-5/8"
	Bottom	1530	1532	1538					2-5/16"	1-3/16"
7/8"	Top	2740		2748	AMPCO	98585	98265	98275	2-3/8"	1-5/8"
	Bottom	2730		2738					2-5/16"	1-3/16"
7/8"	Top	2770		2778		99109	98265	98275	2-1/2"	1-1/2"
	Bottom	2780		2788					2-15/32"	1-15/16"
1"	Top	2400	2402			99109	98175	98245	2-7/32"	1-23/32"
	Bottom	2490	2492						2-11/32"	1-3/16"
1"	Top	2450			SANYMETAL	98715	INCLUDED		2-9/32"	1-5/8"
	Bottom	97280							2-5/16"	1"
1"	Top	2720		2728	AMPCO	99585	98265	98275	2-11/32"	1-5/8"
	Bottom	2710		2718					2-5/16"	1-3/16"
1"	Top	2760		2768		99109	98265	98275	2-15/32"	2-5/32"
	Bottom	2750		2758					2-1/2"	1-3/8"
1"	Top	2820	2822	2828		99109	98175	98245	2-11/32"	1-5/8"
	Bottom	2810	2812	2818					2-5/16"	1-3/16"
1"	Top	4800			FIAT	99574	98175	98195	2-3/16"	1-5/8"
	Bottom	4700							2-1/8"	13/16"
1"	Top & Bottom	1680		1688	CAPITAL	99109	89830	89820	2-5/16"	2-3/16"
1-1/4"	Top	2420			SHANAHAN	98544	98175	98195	2-9/32"	1-23/32"
	Bottom	2430							2-1/4"	1-1/8"

**FOR ROUND EDGE (METAL) DOORS**

Post Size	Location	Chrome Plated Zamac	Unplated Zamac	Description	Use Pin	Use Pintle or Candle	Use Cam
1"	Top	4540	4546	AMOCO & METPAR	98584	98175	98185
	Bottom	4060	4066				
1"	Top	4550	4556	FLUSH METAL	98584	98175	98185
	Bottom	4090	4096				
1"	Top		4646	GENERAL & KNICKERBOCKER	98614	97275	97265
	Bottom		4636				
1"	Top	4680	4686	SANYMETAL	98715	INCLUDED	
	Bottom	97290	97295				



1550



8340



8309



8330

8329



8349



**ALCOVE CLIPS**



6670

6675

6660

6665

POST SIZE	CHROME PLATED ZAMAC	CHROME PLATED BRASS	POLISHED BRASS	CAST STAINLESS STEEL	STAMPED STAINLESS STEEL	DESCRIPTION
1" to 1-1/4"	1550					Right Angle-Curved Molding (Metpar)
1" to 1-1/4"	8330					Right Angle-Curved Molding (Flush Metal)
ALL					8329	Offset-Double High (1/2", 1/4" Per Side)
ALL	8340	8341	8342	8343	8349	Offset-Laminate 1/4" (1/8" Per Side)
ALL					8369	Equal Panel & Post (1-1/2" High x 2-5/8" Long)
ALL					8309	Equal Panel & Post (3" High x 2-3/4" Long)
ALL					8319	Equal Panel & Post (3" High x 54" Long)
ALL					111139	Equal Panel & Post (3" High x 57" Long)



6715

6680

6695

6725

6705

**HEADRAIL END PLUGS**

POST SIZE	CHROME PLATED ZAMAC	SILVER PAINTED STEEL	GRAY NYLON	DESCRIPTION
ALL	6670	6672	6675	Anti-Grip (For all Jacknob Headrail)
1"	6660		6665	Rectangle
1"			6715	Flat (Marlite)
1-1/4"	6680			Rectangle
1-1/2"			6695	Anti-Grip (Shanahan)
1-1/4"			6725	Anti-Grip (Columbia)
1-1/2"			6705	Anti-Grip (Columbia)
3/4"	6710			Rectangle (Ampco)
1"	6700			Rectangle (Ampco)
1-1/4"	6690			Rectangle (Ampco)
3/4"			6835	For Headrail with Tracks
1"			6765	For Headrail with Tracks
1-1/4"			6845	For Headrail with Tracks



6710

6700

6690

**SQUARE TUBING**

ALUMINUM	DESCRIPTION
98334	1-1/4" x 10' Length (Use with #3030 Post Shoe)
98434	1-3/4" x 10' Length (Use with #3040 Post Shoe)

**HEAT SINK ("T" Style)**

ALUMINUM	DESCRIPTION
81172	1" x 10' Length
81182	1" x 5' Length

**POST CAPS & PLUGS**

CHROME PLATED ZAMAC	NYLON	DESCRIPTION
6500		1-3/4" Square Post Cap
	6515	1-3/4" Square Post Plug

**CURTAIN HOOKS**

BRASS NICKEL PLATED	STAINLESS STEEL	DESCRIPTION
6281		For 1-1/8" Square & Round
	6290	Used with Headrail Containing Curtain Tracks

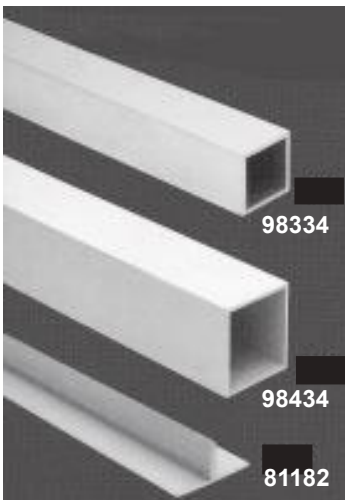

98334

98434

81182



6500

6515

6281

6290





2110



2150



2139



2169



2179



2109



2129



2579

EXTRUDED ALUMINUM HEADRAIL				
POST SIZE	LENGTHS			
	62"	84"	8-1/2'	10'
1/2"			80022	80122
3/4"			80032	80132
1"			80042	80142
1-1/4"			80052	80152
3/4"				80188
1"	80268	80368		80168



80022



80032



80042



80052



80368

POST SIZE	CHROME PLATED ZAMAC	ANODIZED ALUMINUM EXTRUSION	STAMPED STAINLESS STEEL	DESCRIPTION
HEADRAIL CONNECTOR PACKS				
3/4"		15762		Headrail Connector Pack (with Fasteners)
1"		15772		Headrail Connector Pack (with Fasteners)
1-1/4"		15782		Headrail Connector Pack (with Fasteners)
HEADRAIL BRACKETS				
1"	2110			Headrail Bracket (ASP)
1"			2139	Headrail Bracket (Mini)
1"	2150		2169	Headrail Bracket
1-1/4"	2170	2172 *	2179	Headrail Bracket *(Aluminum Painted Zamac)
3/4"			2109	For Headrail with Track
1"			2129	For Headrail with Track
1-1/4"			2579	For Headrail with Track



15772



7369



7359

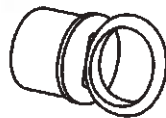

6130

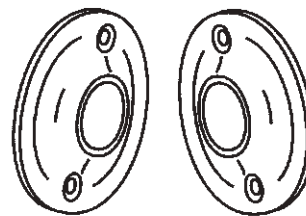

16140

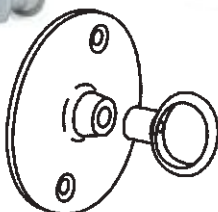

16120

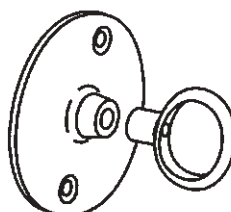

16110

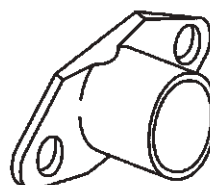

6220

**PAPER ROLL HOLDERS**

CHROME PLATED STEEL	DESCRIPTION
7359	Single Roll Paper Holder
207359	Single Roll (Case of 50)
7369	Double Roll Paper Holder
207369	Double Roll (Case of 25)

**CURTAIN ROD FLANGES**

CHROME PLATED STEEL	DESCRIPTION
16120	3/4" Eye Loop Pack (with Fasteners)
16110	1" Eye Loop Pack (with Fasteners)
6220	1" End Flange
16140	1" Rod Holder Set (with Fasteners)
6130	1" Eye Loop (2 pc)

## SCREW PACKS

ONE WAY				SIX-LOBE		USED FOR	For Material Thickness or Depth
CHROME PLATED STEEL	CHROME PLATED BRASS	BRASS PLATED STAINLESS	STAINLESS STEEL	CHROME PLATED STEEL	STAINLESS STEEL		
10	11	12	19	60010	60019	1-1/4" Hinge or Strike and Keeper	1-1/4"
20	21	22	29	60020	60029	1" Wall Bracket	1"
30		32	39	60030	60039	"U" Bracket	7/8" to 1-1/4"
40	41	42	49	60040	60049	Two Piece Wall Bracket	7/8" to 1-1/4"
50		52	59	60050	60059	5020 Slide Latch	7/8" to 1-1/4"
60		62	69	60060	60069	5020 Slide Latch and Door Pull	5/8" to 1-1/8"
70			79			Urinal Screen Bracket	7/8" to 1-1/4"
80	81	82	89	60080	60089	5050 or 5151 Latches	1"
90		92	99	60090	60099	5050 Latch and Door Pull	1" to 1-1/4"
100		102	109	60100	60109	Hook or Door Stop	7/8" Min.
110				60110		Paper Roll Holder (#12 x 1-1/2" Screws)	1" Min.
120				60120		Paper Roll Holder (#14 x 1-1/2" Screws)	1" Min.
130				60130		Flat Strike & Keeper	1" Min.
140	141	142	149	60140	60149	1-1/4" Wall Bracket	1-1/4"
150						3040 Pilaster Shoe	1-3/4"
160	161	162	169	60160	60169	8340 Alcove Clips (2 pc)	1" to 1-1/4"
220		222	229		60229	5400 Door Pull	7/8" to 1-1/4"
240			249		60249	5701/5703 Throw Latch	7/8" to 1-1/8"
250			259			6200 Door Pull	1/2" to 1"
260			269			Open End Pilaster Shoe	5/8" Min.
270			279			6251/6253 Door Pull	3/4" to 1"
			289		60289	8503 Floor Mounted Pilaster Bracket	1-1/4"
340			349			1/2" Wall Bracket	1/2"
350			359	60350	60359	3/4" Wall Bracket	3/4"
360	361	362	369			7/8" Wall Bracket	7/8"
370	371	372	379		60379	1" Hinge or Strike and Keeper	1"
			399			Flat Back Hinge	1-3/8" Min.
500			509		60509	1-1/4" x 57-1/2" Continuous Wall Bracket	1-1/4"
510						5400/5440 Door Pulls	1"
520			529			1" x 57-1/2" Continuous "U" Bracket	1"
			569			Pivot Hinge (7803)	1"
			579			Pivot Hinge (7813)	3/4" or 1"
580			589		60589	1" x 57-1/2" Continuous "U" Bracket	1"
590			599			Hook (for 1/2" Solid Surface)	1/2"
	601		609			4151 Pilaster Mounted Door Stop	1-1/4"
610			619		60619	3/4" Hinge or Strike and Keeper	3/4"
8223						Floor Mounted 1" Aluminum U-Channel	1"
114140			114149			Headrail Wall Brackets	ALL

### FOR PIANO HINGES

			709			Sheet Metal Screws	5/8" Min.
			719			1/2" Door & Pilaster Post	1/2"
			729	60729		3/4" Door & Pilaster Post	3/4"
			739	60739		7/8" Door & Pilaster Post	7/8"
			749	60749		1" Door & Pilaster Post	1"
			759	60759		1-1/4" Door & Pilaster Post	1-1/4"

### FOR SURFACE MOUNTED HINGES

			429	60429		1/2" Door - 1/2" Pilaster Post	
430	431	432	439	60439		1" Door - 1-1/4" Pilaster Post	
440	441		449	60449		7/8" Door - 1-1/4" Pilaster Post	
450	451		459	60459		3/4" Door - 3/4" Pilaster Post	
460	461		469	60469		3/4" Door - 1" Pilaster Post	
470	471		479	60479		1" Door - 1" Pilaster Post	
480	481		489	60489		1/2" Door - 1" Pilaster Post	
490	491		499	60499		1/2" Door - 3/4" Pilaster Post	

## ANCHORS

STEEL ZAMAC PLASTIC

For No. 10 and 12 Screws		9005
For No. 14 and 16 Screws		9015
3/8" Expansion		8106
3/8" Double Expansion		8116
1/2" x 3" Anchor Sleeve with 3/8 Nut & Washer	95154	

9005

9015

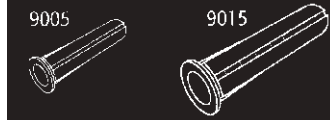

## MISCELLANEOUS

DESCRIPTION	ZINC PLATED STEEL	STAINLESS STEEL
1/4-20 x 3" Toggle Bolt Assembly (Pan Head)	89904	
1/4-20 x 4" Toggle Bolt Assembly (Flat Head)	89924	
1/4-20 Toggle Wing	96164	
1/4" Flat Washer	96814	
1/4" Fender Washer		96819
1/4" Split Lock Washer	96834	
5/16-18 x 3" Hex Bolt	94964	
5/16-18 Hex Locknut - Nylon Stop	96274	
5/16-18 Internal Lock Washer	96884	
5/16-18 External Lock Washer	96894	
3/8-16 x 2-1/2" Hex Bolt	95144	
3/8-16 Hex Nut	96324	96329
3/8-16 x 7/8" Square Nut	96356	
3/8-16 T-Nut	96374	
3/8" Flat Washer	96924	
3/8" Split Lock Washer	96914	
#8 Finishing Washer (for Oval Head Screws)	96623	

### THREADED WIRE & RODS

10-24 x 1/2"	87004
10-24 x 3/4"	87024
10-24 x 7/8"	87034
10-24 x 1-1/8"	87054
10-24 x 1-3/8"	87074
10-24 x 1-1/2"	87094
10-24 x 1-15/16"	87134
3/8-16 x 4"	87304
3/8-16 x 6"	87334
3/8-16 x 8"	87374
3/8-16 x 10"	87394
3/8-16 x 12"	87404

### TOGGLE BOLT



MATERIAL THICKNESS	SURFACE HINGES		HINGE BRACKETS WALL BRACKETS STRIKE & KEEPERS		STAMPED STAINLESS STEEL BRACKETS	
	BARREL NUT	SHOULDER SCREW	BARREL NUT	SHOULDER SCREW	BARREL NUT	SHOULDER SCREW
1/2"	1/2" (9703)	3/8" (9883)	1/2" (9703)	1/2" (9773)	1/2" (9709)	3/8" (9889)
5/8"	1/2" (9703)	1/2" (9773)	X	X	X	X
3/4"	5/8" (9713)	1/2" (9773)	5/8" (9713)	3/4" (9783)	5/8" (9719)	1/2" (9779)
7/8"	5/8" (9713)	3/4" (9783)	5/8" (9713)	15/16" (9793)	5/8" (9719)	3/4" (9789)
1"	5/8" (9713)	15/16" (9793)	5/8" (9713)	1-1/16" (9803)	5/8" (9719)	15/16" (9799)
1-1/8"	5/8" (9713)	15/16" (9793)	5/8" (9713)	1-3/16" (9813)	5/8" (9719)	1-1/16" (9809)
1-1/4"	5/8" (9713)	1-3/16" (9813)	5/8" (9713)	1-5/16" (9823)	5/8" (9719)	1-3/16" (9819)
1-3/8"	5/8" (9713)	1-5/16" (9823)	X	X	X	X
1-1/2"	1/2" (9703)	1-1/2" (9873)	X	X	X	X
1-5/8"	5/8" (9713)	1-1/2" (9873)	X	X	X	X
1-3/4"	(2) 5/8" (9713)	1-1/8" Wire (87054)	X	X	X	X

### SIX-LOBE FASTENERS

1/2"	1/2" (88203)	3/8" (88223)	1/2" (88203)	1/2" (88233)	1/2" (88209)	3/8" (88229)
5/8"	1/2" (88203)	1/2" (88233)	X	X	X	X
3/4"	5/8" (88213)	1/2" (88233)	5/8" (88213)	3/4" (88243)	5/8" (88219)	1/2" (88239)
7/8"	5/8" (88213)	3/4" (88243)	5/8" (88213)	15/16" (88253)	5/8" (88219)	3/4" (88249)
1"	5/8" (88213)	15/16" (88253)	5/8" (88213)	1-1/16" (88263)	5/8" (88219)	15/16" (88259)
1-1/8"	5/8" (88213)	15/16" (88253)	5/8" (88213)	1-3/16" (88273)	5/8" (88219)	1-1/16" (88269)
1-1/4"	5/8" (88213)	1-3/16" (88273)	5/8" (88213)	1-5/16" (88283)	5/8" (88219)	1-3/16" (88279)
1-3/8"	5/8" (88213)	1-5/16" (88283)	X	X	X	X
1-1/2"	(2) 5/8" (88213)	7/8" Wire (87034)	X	X	X	X
1-5/8"	(2) 1/2" (88203)	1-1/8" Wire (87054)	X	X	X	X
1-3/4"	(2) 5/8" (88213)	1-1/8" Wire (87054)	X	X	X	X

**MACHINE SCREWS**

SIZE/HEAD TYPE	CHROME PLATED STEEL	CHROME PLATED BRASS	BRASS PLATED STAINLESS	ZINC PLATED STEEL	STAINLESS STEEL
8-32 x 5/8" One Way Oval Head	9403				9409
8-32 x 3/4" One Way Oval Head	9413				9419
8-32 x 1" One Way Oval Head	9423		9422		9429
8-32 x 1-1/8" One Way Oval Head	9443		9442		9449
8-32 x 1-3/8" One Way Oval Head	9463				9469
8-32 x 1-5/8" One Way Oval Head	9483		9482		9489
10-24 x 3/4" One Way Round Head	9513				
10-32 x 1/2" Slotted Flat Head	93783				
10-32 x 3/4" One Way Round Head	9543				
1/4-20 x 3/4" One Way Round Head		9571			
1/4-20 x 3" Phillips Pan Head	94823				
1/4-20 x 4" Phillips Flat Head				94884	

**One Way Round Tapping Screws**

SIZE	CHROME PLATED STEEL	BRASS PLATED	STAINLESS STEEL
6 x 3/4"	9073		
8 x 3/8"	9103		
8 x 1/2"	9113		
10 x 3/8"	9163		
10 x 1/2"			9159
10 x 5/8"	9173	9172	9179
10 x 3/4"	9193		
10 x 1"	9203		
12 x 5/8"	9213		
12 x 1-1/2"	9233		
14 x 1/2"	9253		
14 x 5/8"	9263		
14 x 1"	9283		
14 x 1-3/4"	9343		
14 x 2"	9313		
14 x 2-1/2"	9323		
14 x 3"	9333		

**PHILLIPS TAPPING**

SIZE/HEAD TYPE	CHROME PLATED STEEL	BRASS PLATED STAINLESS	STAINLESS STEEL
10 x 1/2" Phillips Flat Head	90864		
10 x 5/8" Phillips Flat Head	90884		
10 x 3/4" Phillips Pan Head	90933		
10 x 1" Phillips Flat Head	91013		
10 x 1-3/4" Phillips Flat Head			91109
12 x 5/8" Phillips Pan Head	91353		
12 x 1-1/2" Phillips Pan Head	91553		
12 x 2" Phillips Pan Head	91783		
14 x 1/2" (AB) Phillips Pan Head	92003		
14 x 5/8" (A) Phillips Pan Head	92063	92072	92079
14 x 5/8" (AB) Phillips Pan Head	92093		
14 x 1" Phillips Pan Head	92153		
14 x 1-1/2" Phillips Flat Head			92309
14 x 1-3/4" Phillips Pan Head	92353	92362	92369
14 x 2" Phillips Pan Head	92403		92419
14 x 2-1/2" Phillips Pan Head	92503		92519
14 x 3" Phillips Pan Head	92603		
12 x 1-1/2" Square Recess Pan Head	91543		

**10-24 SHOULDER SCREWS**

SIZE/HEAD TYPE	CHROME PLATED STEEL	CHROME PLATED BRASS	BRASS PLATED	STAINLESS STEEL
3/8" One Way Round Head	9883	9881		9889
1/2" One Way Round Head	9773	9771	9772	9779
3/4" One Way Round Head	9783	9781	9782	9789
15/16" One Way Round Head	9793	9791	9792	9799
1-1/16" One Way Round Head	9803	9801	9802	9809
1-3/16" One Way Round Head	9813	9811	9812	9819
1-5/16" One Way Round Head	9823	9821	9822	9829
1-5/16" Phillips Round Head		9861		
1-1/2" One Way Round Head	9873			

**BARREL NUTS**

SIZE/HEAD TYPE	CHROME PLATED STEEL	CHROME PLATED BRASS	BRASS PLATED	STAINLESS STEEL
8-32 x 1/2" Unslotted Head	9763		9762	9769
10-24 x 1/2" Phillips Round Head	9723	9721		
10-24 x 1/2" One Way Round Head	9703	9701	9702	9709
10-24 x 5/8" One Way Round Head	9713	9711	9712	9719

**SIX LOBE FASTENERS  
(T-27 HEADS)**

**10-24**

**BARREL NUTS**

LENGTH	CHROME PLATED STEEL	STAINLESS STEEL
1/2"	88203	88209
5/8"	88213	88219

**10-24**

**SHOULDER SCREWS**

LENGTH	CHROME PLATED STEEL	STAINLESS STEEL
3/8"	88223	88229
1/2"	88233	88239
3/4"	88243	88249
15/16"	88253	88259
1-1/16"	88263	88269
1-3/16"	88273	88279
1-5/16"	88283	88289
1-3/8"	88293	

# 3/8" has full threads (no shoulder)

**PAN HEAD TAPPING SCREWS  
Without Center Pin**

SIZE	CHROME PLATED STEEL
12 x 1-1/2"	91613
14 x 1-3/4"	92373

**10-24**

**SHOULDER SCREWS  
Without Center Pin**

LENGTH	CHROME PLATED STEEL
1/2"	88133
3/4"	88143
15/16"	88153
1-1/16"	88163
1-3/16"	88173
1-5/16"	88183

**8-32 OVAL HEAD  
(T-20)**

LENGTH	CHROME PLATED STEEL	STAINLESS STEEL
5/8"	88313	88319
3/4"	88323	88329
1"	88333	88339
1-1/8"	88343	88349
1-3/8"	88353	88359
1-5/8"	88363	88369

All Barrel Nut & Shoulder Screws Have a 1/4" Outer Diameter

**TAPPING SCREWS**

SIZE/HEAD TYPE	CHROME PLATED STEEL	STAINLESS STEEL
10 x 5/8" Pan Head	90963	90969
10 x 3/4" Pan Head	90943	90949
10 x 1" Flat Head (T-20)	91053	91059
12 x 7/16" Pan Head		91429
12 x 1-1/2" Truss Head	91813	91819
12 x 2" Truss Head	91913	91919
12 x 2-1/2" Truss Head	91903	91909
14 x 1/2" Pan Head	92083	92089
14 x 5/8" Pan Head	92193	92199
14 x 5/8" Truss Head	92213	92219
14 x 3/4" Pan Head	92243	90929
14 x 1" Truss Head	92183	92189
14 x 1-1/2" Pan Head		92319
14 x 1-3/4" Pan Head	92423	92429
14 x 2" Pan Head	92383	92389
14 x 2-1/4" Pan Head		92449
14 x 2-1/2" Pan Head	92393	

B - "Blunt" Tip (Type MS)

\* - Type #410 Stainless Steel



LISTED BY MANUFACTURER (Available in other materials & finishes)

**ACCURATE**



**AII AMERICAN**



**AMERICAN SANITARY**



**AMPCO**





LISTED BY MANUFACTURER (Available in other materials & finishes)

**AMPCO**



**BOBRICK**



**COLUMBIA**



LISTED BY MANUFACTURER (Available in other materials & finishes)

**COMRES MANUFACTURING**



**COMTEC / CAPITAL PARTITIONS**



**FIAT**



LISTED BY MANUFACTURER (Available in other materials & finishes)

**FLUSH METAL**

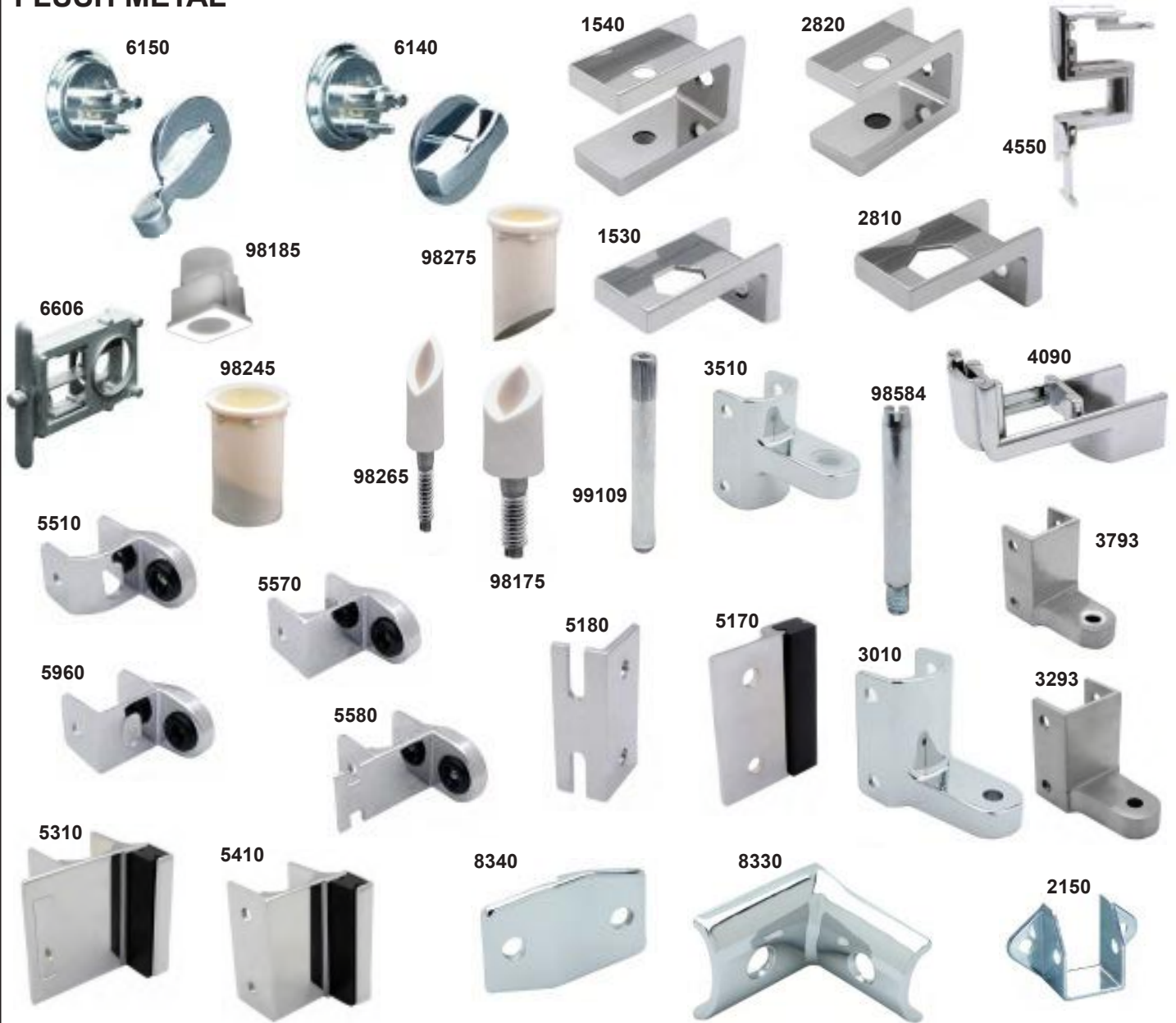

**GENERAL PARTITION**





LISTED BY MANUFACTURER (Available in other materials & finishes)

**GENERAL PARTITION (continued)**



**GLOBAL STEEL**





LISTED BY MANUFACTURER (Available in other materials & finishes)

**GLOBAL STEEL (continued)**

5410

5510



5310



5230



**HADRIAN**

5778



5878



7978  
7988



7005

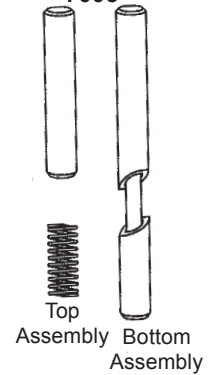

4988

**KNICKERBOCKER**

3910



4646



6160

97275



6170

98614



111950

5470



4290



4260



3420



4636



**METPAR**

1550



4240



6090



5090



2150



LISTED BY MANUFACTURER (Available in other materials & finishes)

**METPAR (continued)**

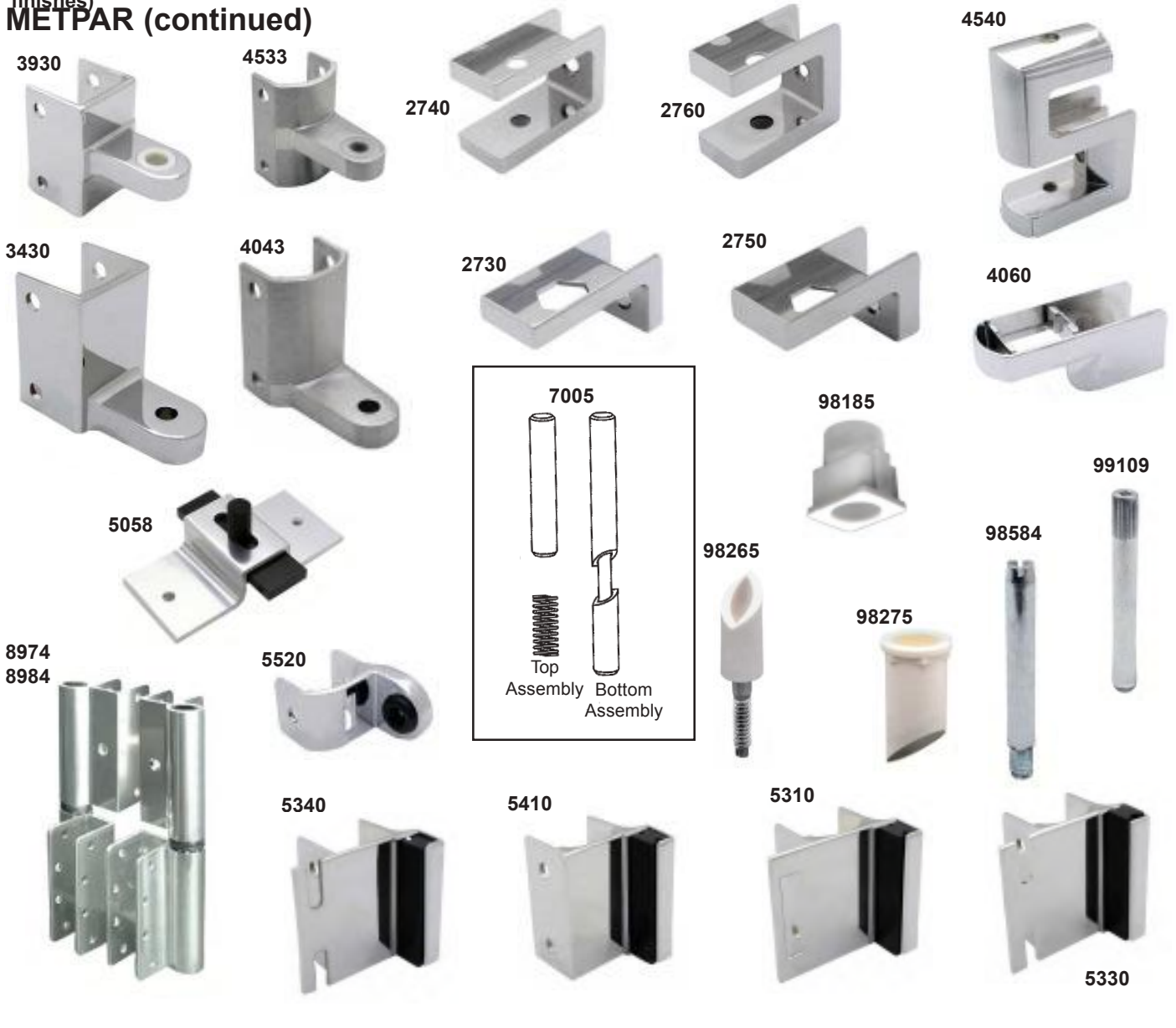

**MILLS**



LISTED BY MANUFACTURER (Available in other materials & finishes)

**SANTANA / HINY HIDERS**



5058



6309

8974  
8984

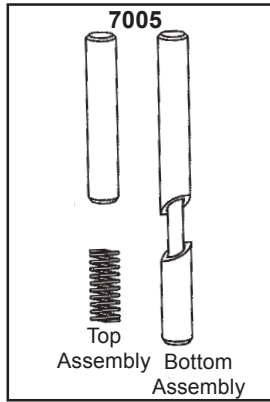

**SANYMETAL**



6540



3960



3900



4280



2450



4686



3460



3060



97280



97295



7978  
7988



5180



5130



5510



5170



98175



8860



98715

**SHANAHAN**



2420



3650



98175



5180



98544



5170



2430



3150



98195



6695



CHROME PLATED ZAMAC	CHROME PLATED BRASS	POLISHED BRASS	CAST STAINLESS STEEL	STAMPED STAINLESS STEEL	HOOKS
4000	4001	4002	4003		Hook & Bumper Combination (7/32" Dia. Holes)
			4113		Hook & Bumper Combination (1/4" Dia. Holes)
4020	4021	4022	4023		Two Prong Hook (7/32" Dia. Holes)
4260					Hook & Bumper Combination (7/32" Dia. Holes)
4280					Hook & Bumper Combination (1/4" Dia. Holes)
4290					Hook (3/16" Dia. Holes)
				4009	Flat & Bumber- 5/8" x 2-13/16" Extension (3/16" Dia. Holes)
				6519	Flat-1" x 1" Extension (9/32" Dia. Holes)
				6529	Flat-1/2" x 1" Extension (1/4" Dia. Holes)
DOOR STOPS					
4120		4122 *	4123	4129	2" High *Brass Plated Zamac
	4151		4153		Pilaster Mounted

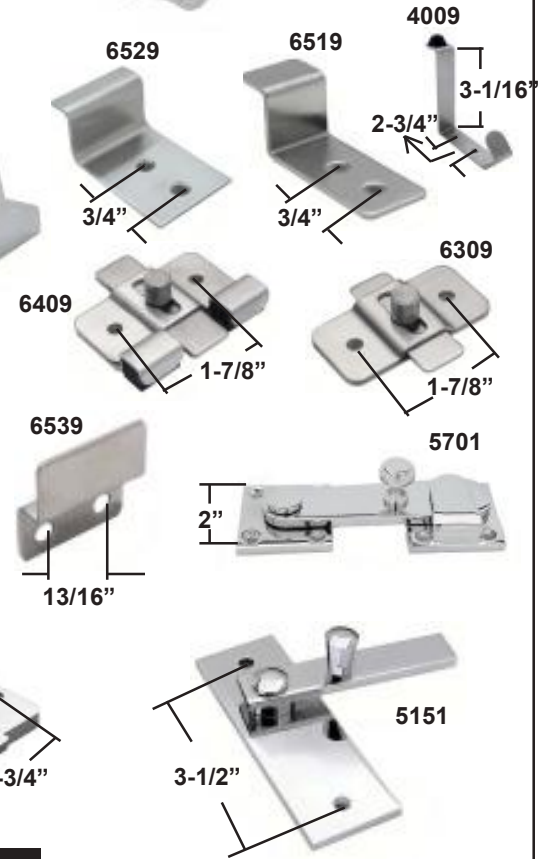
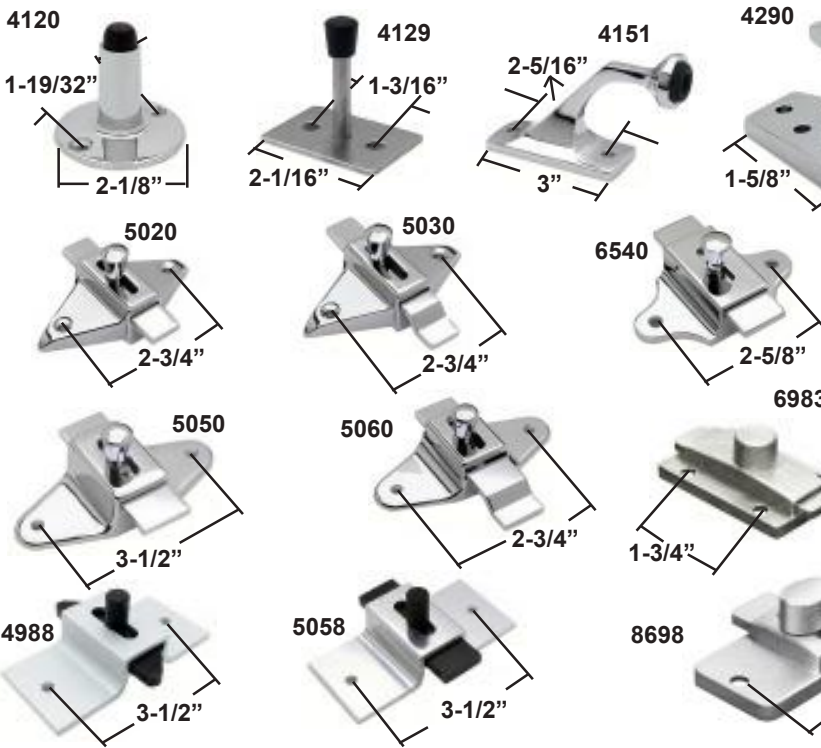
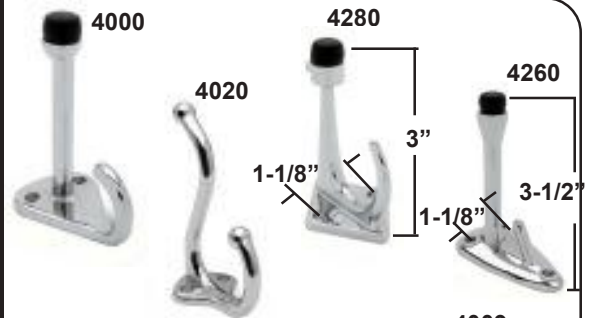

FOR PROPER FUNCTION, ALL LATCHES REQUIRE A MATING STRIKE & KEEPER

CHROME PLATED ZAMAC	CHROME PLATED BRASS	POLISHED BRASS	CAST STAINLESS STEEL	CLEAR ANODIZED ALUMINUM	BRITE-DIP ALUMINUM	STAMPED STAINLESS STEEL	SLIDE LATCHES
5020	5021	5022	5023				Standard for #6200 Door Pull (2-3/4" Centers)
5030	5031	5032	5033				Offset Bar with #5020 (2-3/4" Centers)
5040	5041	5042	5043				Reverse Offset Bar with #5020 (2-3/4" Centers)
5000			5003				Reverse Offset Bar with #5050 (3-1/2" Centers)
5050	5051	5052	5053				Standard for #5400 Door Pull (3-1/2" Centers)
5060	5061	5062	5063				Offset Bar with #5050 (3-1/2" Centers)
6540							Standard for #6020 Door Pull (2-5/8" Centers)
			6983				Straight Bar - Four Hole (1-1/2" Centers Height)
8698 *							Straight Bar (2-3/4" Centers) *Satin Finish
				4988	4984		Angled Bar (3-1/2" Centers)
				5054	5058		Straight Bar (3-1/2" Centers)
						6049	With Keeper
						6069	With Keeper, Indicator and Door Pull
						6309	For all Stamped Stainless Steel Strike & Keepers
						6409	Inswing Latch & Strike Combination
						6539	Keeper for #6409
THROW LATCHES							
	5151		5153				Use with "T" Type Strike & Keepers
	5701		5703				Heavy Duty Latch & Keeper





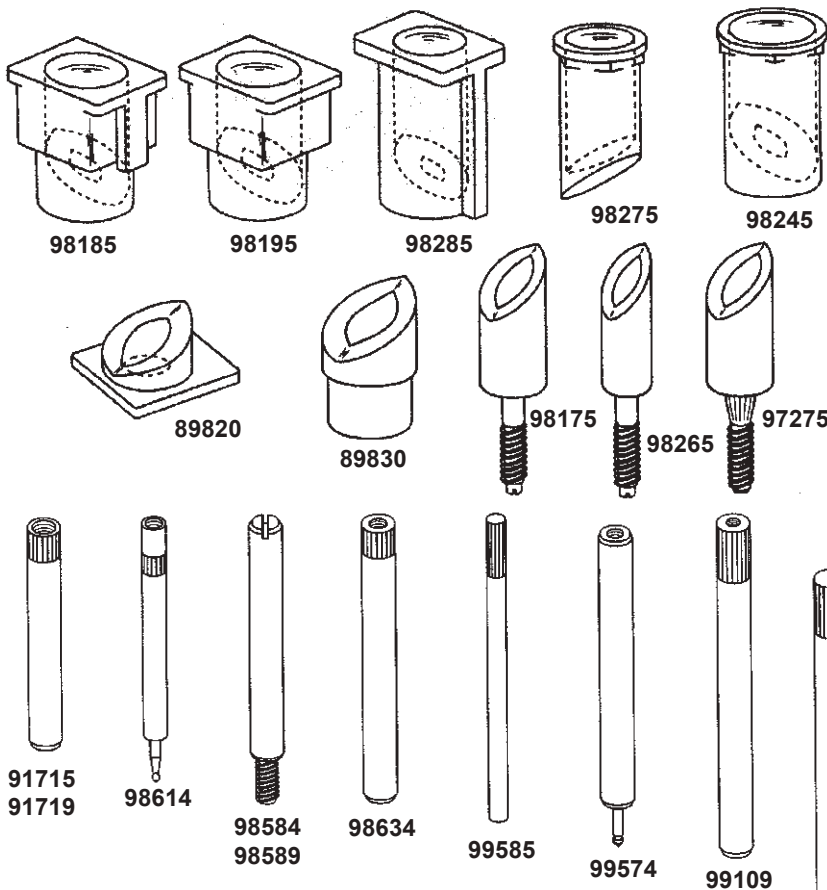

PART #		CAMS	
89820	M-Hinges (3540 & 3550)		
98185	Square - Unshaved		
98195	Square - Shaved		
98245	Round for 5/8" Pintle		
98275	Round for 1/2" Pintle		
98285	Round with Keylock (Use with #97205 Pintle only)		
PART #		PINTLES	
89830	M-Hinges (3540 & 3550)		
97205	1/2" Diameter (Use with #98285 Cam only)		
97275	5/8" Diameter (Knickerbocker)		
98175	5/8" Diameter		
98265	1/2" Diameter		
98305	Nut and Washer Pack for Pintles		
CAM & PINTLE SETS (WITH NUTS & WASHERS)			
PART #	PINTLE	CAM	DESCRIPTION
97305	98265	98275	5/8" Round
97315	97205	98285	5/8" Round with Keylock
97325	98175	98245	3/4" Round
97335	98175	98195	7/8" Square - Shaved
97345	98175	98185	7/8" Square - Unshaved

PART #	MATERIAL	DIMENSIONS	USED FOR
98715	Knurled Plastic	3/8" Dia. x 2-1/2" L	Sanymetal
98719	Knurled Stainless	3/8" Dia. x 2-3/4" L	General
98614	Knurled Steel	1/4" Dia. x 2-3/4" L	General
98584	Threaded Steel	3/8" Dia. x 3" L	Ampco, Metpar & Flush Metal
98589	Threaded Stainless	3/8" Dia. x 3" L	Ampco, Metpar & Flush Metal
98634	Knurled Steel	5/16" Dia. x 3" L	All American
99585	Knurled Steel	7/32" Dia. x 3-1/4" L	Ampco
99574	Zinc Plated Steel	7/16" Dia. x 3-5/16" L	Fiat
99109	Knurled Steel	3/8" Dia. x 3-1/2" L	
99119	Knurled Stainless	3/8" Dia. x 3-1/2" L	
98544	Zinc Plated Steel	3/8" Dia. x 3-3/4" L	Shanahan

PART #	CANDLE CAMS
97435	Metpar
97245	General
97265	Knickerbocker

PART #	INTEGRAL HINGE SET
7005	Includes Three Set Screws (T-7 Bit Required for Installation)

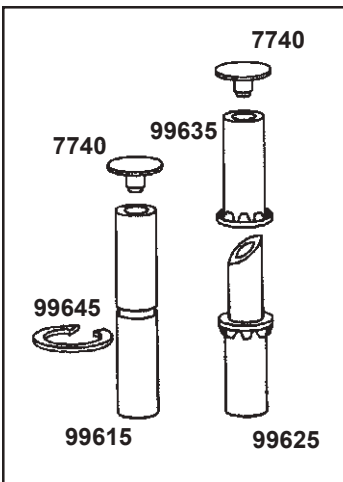

7035	
CONTENTS	USED WITH
7740 Nylon Cap	Round Barrel Hinge Parts for Surface Mounted Hinges (7011, 7021, 7033, 7043, 7053, 7063, 7113, 7123)
99615 Nylon Pin	
99625 Nylon Pintle	
99635 Nylon Cam	
99645 Nylon Retaining Ring	
7405	
CONTENTS	USED WITH
97015 Pintle	Square Barrel Hinge Parts for Surface Mounted Hinges (7413, 7423)
97025 Nylon Pintle Housing	
97035 Nylon Cam	
97045 Nylon Pin Assembly	
97055 Nylon Pin Housing	
97065 Nylon Cap	

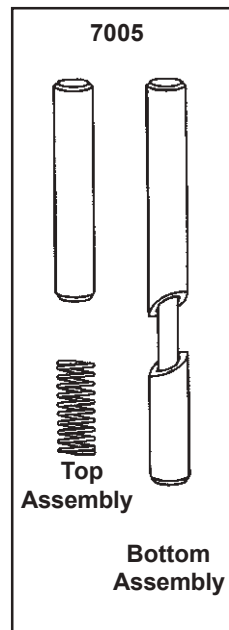
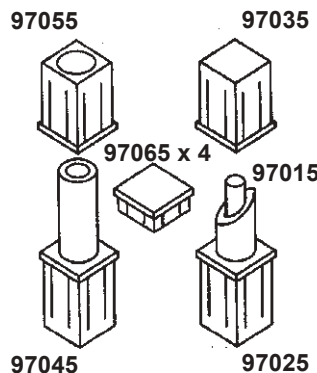

# New Products

8698



## SLIDE LATCH

Satin Finish Cast Zamac Design  
2-3/4" center-to-center holes

6983



## SLIDE LATCH

Heavy Duty Cast Stainless  
Steel Design



## HINGED BRACKET

Can be rotated for any angle application  
111359 1" Hinged Wall Bracket  
111359 1-1/4" Hinged Wall Bracket

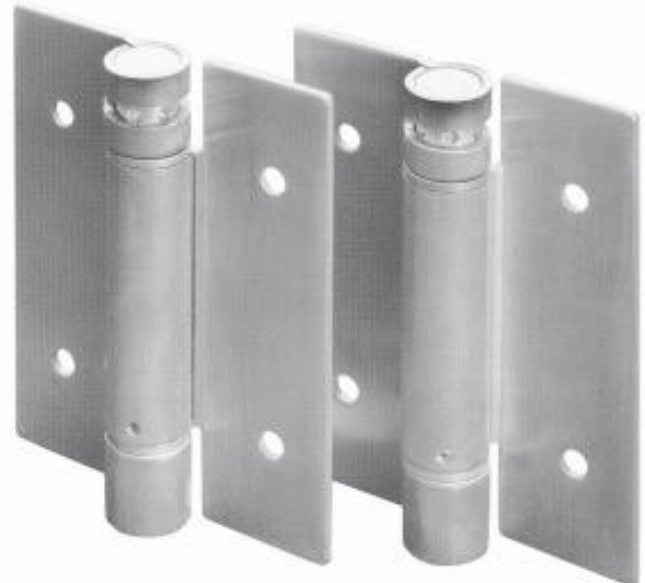

## SPRING LOADED SURFACE HINGE

Heavy duty stainless steel tension adjust-  
able

8643 4" high - polished

8649 4" high - satin

8653 5" high - polished

8659 5" high - satin